





























TOKU ATTACHMENT CATALOGUE



General Attachment Catalogue

Table of Content

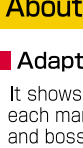
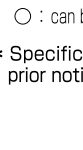
	Powerful concrete crusher/Reinforced concrete cutter/ Pulverizer/TOKU series
	TOKU TDX Cutter 3·4P
	TOKU Primary Crusher TD5·6P
	TOKU Primary Crusher TD Light 7·8P
	TOKU Primary Crusher9·10P
	TOKU Cutter11·12P
	TOKU FC Cutter 13·14P
	Mini TOKU TDF-10 15P
	Automatic TOKU Mechanism 16P
	TOKU Pulverizer 17P
	Magnet TOKU Pulverizer 18P
	Original powerful grasping machines, grasper series
	Grasper V3 19·20P
	Powerful Grasper V21·22P
	Swing Grasper VL23P
	Magnet Swing Grasper24P
	Rock Grasper R25P
	Rock Swing Grasper RL26P
	Total Swivel Grasper VS27P
	Timber Grasper28P
	Bucket & Fork 29P
	Orange Bucket 30P
	Grasper Special Claw31~35P
	How to order a special claw model36P
	Concrete chip crusher
	Bucket Crusher 37·38P
	Cutting machines
	Concrete Planer 39P
	Asphalt Planer 40P
	Sifter, powerful coppice and grass cutter
	DD-Riddle41P
	Grass Cutter 42P

	Deep digging, clam shell bucket
	Clam Shell Bucket CB/RC type43·44P
	Large Clam Shell Bucket KAI type 45·46P
	Foundation improvement, sifter, stirring machines
	Drive Mixing47P
	Mixing Fork 48P
	Honeycomb Skeleton Bucket49P
	Skeleton Bucket50P
	Digging machine
	Mini-Earth Augar51·52P
	Slope Finish Bucket
	Tilt Slope Bucket53P
	Slope Bucket Y-154P
	Slope Bucket Y-254P
	Slope Bucket N-155P
	A wide variety of regular buckets
	G Bucket56P
	Triangle Bucket57P
	Ripper Bucket58P
	Single Ripper58P
	Arm extension mechanism, Original special custom-made models
	Extension Arm59P
	Original Special Models 60P
	List of corresponding hydraulic shovels by model
	List of corresponding hydraulic shovels by model 61·62P

About the descriptions used in this catalog:

■ Adaptor type

It shows if the relevant model can be attached to power shovels of each manufacturer by changing the adaptor such as mounting pins and bosses.

○ : can be attached. × : cannot be attached (only limited models can be attached.)

* Specifications of this catalogue are subject to change without prior notice for improvement.

Twin cylinder steel frame / Reinforced steel rods / SRC building cutter / crusher

TOKU TDX Cutter



**Great cutting of concrete
as well as steel frame!
Great for demolishing SRC!**

Launch of our strongest ever TOKU cutter. The TOKU TDX cutter series!! It features a large twin cylinder and synchronous link with two-arm synchronization!! It ensures first-rate cutting power in a light weight!! The extraordinary cutting power which can cut and crush steel-frame and reinforced-steel-rod concrete buildings delivers excellent work efficiency at any demolition site. The swivel has two types: total swivel and automatic. Select one according to your application.

Hydraulic swivel type

TDX-30S
TDX-40S
TDX-60S
TXL-120S
TDX-120S
TXL-200S
TDX-200S
TDX-300S

Automatic swivel type

TDX-30A
TDX-40A
TDX-60A
TXL-120A
TDX-120A
TXL-200A
TDX-200A
TDX-300A

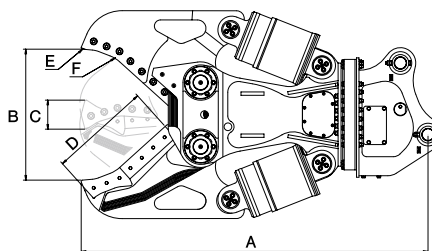

■ Specification table for TOKU TDX cutter Type S / 360°hy draulic swivel type

M o d e l	TDX-30S	TDX-40S	TDX-60S	TXL-120S	TDX-120S	TXL-200S	TDX-200S	TDX-300S
Main body class reference ton	3~4	4~5	6~8	12-ton class standard machine 12-ton class high-class demolition machine 7-ton class tower demolition machine	10~14	20-ton class standard machine 20-ton class high-class demolition machine 12-ton class tower demolition machine	20~22	30~35
Maximum working pressure kgf/cm ²	250		280			320		
Main body length A mm	1,120	1,310	1,570	1,850	1,920	2,180	2,260	2,570
Maximum opening width B mm	225	375	505	620	700	780	855	1,010
Wire rod cutter length C mm	-95	-110	-120	-135	-150	-170	-190	-210
Cutter length(base side+top side) D mm	165+103	205+155	260+175	290+185	325+205	365+240	400+260	450+310
Top crushing force E tonf	25	33	43	58	72	85	98	126
Center crushing force F tonf	34	48	60	79	98	118	136	179
W e i g h t kg	315	425	770	1,370	1,500	2,190	2,390	3,590

*Double two-way hydraulic piping are necessary for type S (if the back pressure is morethan 20kgf/cm², drain piping is necessary.) *cannot be mounted to power shovels of different classes.

*The arm of the power shovel should preferably be reinforced to mount a TOKU series.

■ Specification table for Automatic TOKU TDX cutter type A / 360°automatic swivel type

M o d e l	TDX-30A	TDX-40A	TDX-60A	TXL-120A	TDX-120A	TXL-200A	TDX-200A	TDX-300A
Main body class reference ton	3~4	4~5	6~8	12-ton class standard machine 12-ton class high-class demolition machine 7-ton class tower demolition machine	10~14	20-ton class standard machine 20-ton class high-class demolition machine 12-ton class tower demolition machine	20~22	30~35
Maximum working pressure kgf/cm ²	250		280			320		
Minimum working pressure kgf/cm ²	190		250			280		
Main body length A mm	1,120	1,310	1,570	1,850	1,920	2,180	2,260	2,570
Maximum opening width B mm	225	375	505	620	700	780	855	1,010
Wire rod cutter length C mm	-95	-110	-120	-135	-150	-170	-190	-210
Cutter length(base side+top side) D mm	165+103	205+155	260+175	290+185	325+205	365+240	400+260	450+310
Top crushing force E tonf	25	33	43	58	72	85	98	126
Center crushing force F tonf	34	48	60	79	98	118	136	179
W e i g h t kg	320	430	770	1,370	1,500	2,200	2,400	3,600

*Single two-way hydraulic piping is necessary for type A. *Use it above the minimum working pressure. If it is erably be rein-forced to mount a TOKU series. * It cannot be mounted to power shovels of different classes.

below the minimum working pressure, swiveling may be impossible. *The arm of the power shovel should pref-

Powerful Crusher, Wire Rod Cutter

Twin cylinder powerful primary concrete crusher TOKU Primary Crusher TD

First in the industry that has an adapted twin cylinder & synchronous link, in which two crushing claws are synchronized, ensuring greater power in a light weight. The double speed-up valve for TD-200 and higher models has increased the opening speed of the claw in addition to its closing speed (no-load)!! First-rate durability and maintenance are guaranteed with special forged steel used for the upper tip. There are three types of swiveling: free (touch and turn), full-swivel, and automatic. You can select according to your application.



The special steel wire rod cutter allows cutting of reinforced steel rods during concrete crushing. The wire rod cutter is an economical and four-way use type. It exercises its power in first-stage crushing situations such as demolition of buildings and foundations. *The TD-450S is not equipped with a cutter.

You can detach and attach it with two pins, as easily as changing the bucket. Replacement time at your work site is greatly reduced. It is attachable to your current power shovel, with adaptors to fit all sorts of models. If you change your model, simply change the adaptor. A full lineup of models ranging from mini-shovels to big-sized shovels along with the standard type are available. TOKU offers a wide variety of products for meeting customers' requirements.

Free swivel type

TD-30F
TD-40F
TD-60F
TD-120F
TD-200F
TD-300F

Hydraulic swivel type

TD-30S
TD-40S
TD-60S
TD-120S
TD-200S
TD-300S
TD-450S

Automatic swivel type

TD-30A
TD-40A
TD-60A
TD-120A
TD-200A
TD-300A

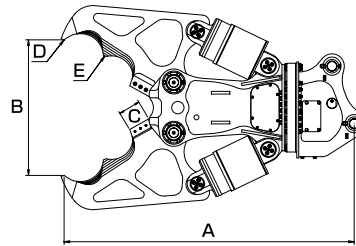

Specification table for TOKU Primary Crusher TD type F / 360 free swivel type

Model	TD-30F	TD-40F	TD-60F	TD-120F	TD-200F	TD-300F
Main body class reference ton	3~4	4~5	6~8	10~14	20~22	30~35
Maximum working pressure kgf/cm ²	250		280	350		
Main body length A mm	1,040	1,240	1,700	2,050	2,370	2,780
Maximum opening width B mm	360	500	620	950	1,100	1,350
Wire rod cutter length C mm	80	95	105	130	160	180
Top crushing force D tonf	24	33	43	73	103	125
Center crushing force E tonf	—	53	69	116	164	198
Weight kg	270	355	685	1,370	2,190	3,350

*Single two-way hydraulic piping is necessary for type F. *The arm of the power shovel should preferably be reinforced to mount a TOKU series. *It cannot be mounted to power shovels in different classes.

Specification table for TOKU Primary Crusher TD type S / 360 hydraulic swivel type

Model	TD-30S	TD-40S	TD-60S	TD-120S	TD-200S	TD-300S	TD-450S
Main body class reference ton	3~4	4~5	6~8	10~14	20~22	30~35	40~45
Maximum working pressure kgf/cm ²	250		280	350			
Main body length A mm	1,040	1,240	1,700	2,050	2,370	2,780	3,200
Maximum opening width B mm	360	500	620	950	1,100	1,350	1,850
Wire rod cutter length C mm	80	95	105	130	160	180	—
Top crushing force D tonf	24	33	43	73	103	125	212
Center crushing force E tonf	—	53	69	116	164	198	404
Weight kg	285	370	695	1,390	2,210	3,360	5,800

*Double two-way hydraulic piping are necessary for type S (if the back pressure is more than 20kgf/cm², drain piping is necessary). *The arm of the power shovel should preferably be reinforced to mount a TOKU series. *It cannot be mounted to power shovels of different classes.

Specification table for Automatic TOKU Primary Crusher TD type A / 360 automatic swivel type

Model	TD-30A	TD-40A	TD-60A	TD-120A	TD-200A	TD-300A
Main body class reference ton	3~4	4~5	6~8	10~14	20~22	30~35
Maximum working pressure kgf/cm ²	250		280	350		
Minimum working pressure kgf/cm ²	190		250	300		
Main body length A mm	1,040	1,240	1,700	2,050	2,370	2,780
Maximum opening width B mm	360	500	620	950	1,100	1,350
Wire rod cutter length C mm	80	95	105	130	160	180
Top crushing force D tonf	24	33	43	73	103	125
Center crushing force E tonf	—	53	69	116	164	198
Weight kg	290	375	695	1,390	2,220	3,370

*Single two-way hydraulic piping is necessary for automatic TOKU Primary crusher TD. *Use it above the minimum working pressure. If it is lower than the minimum working pressure, swiveling may be impossible.

Twin cylinder powerful primary concrete crusher TOKU Primary Crusher TD-Light

The TOKU primary crusher TD has been advanced! The automatic TOKU primary crusher TD-Light is much lighter approximately 13% lighter than the current model!! This is an eco-friendly model that saves resources and operates efficiently (low-fuel consumption cost). The twin cylinder and synchronous link enables synchronization of two crushing claws. It has strong power in a light weight. The double speed-up valve has increased the opening speed of the claw in addition to its closing speed (no-load)!! First-rate durability and maintenance are guaranteed with special forged steel used for the upper tip.



The special steel wire rod cutter can cut reinforced concrete during crushing. The wire rod cutter is an economical and four-way use type. It exercises its power in first-stage crushing situations such as demolition of buildings and foundations.

You can detach and attach it with two pins, as easily as changing the bucket. Replacement time at your work site is greatly reduced. It is attachable to your current power shovel, and adaptable to fit all sorts of models. If you change your model, simply change the adaptor.

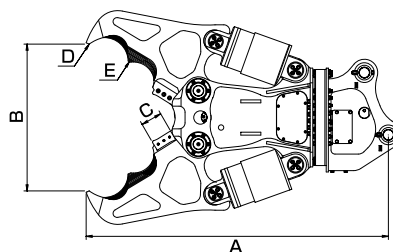

Free swivel type
TDL-120F
TDL-200F
Hydraulic swivel type
TDL-120S
TDL-200S
Automatic swivel type
TDL-120A
TDL-200A

■ Specification table for TOKU Primary Crusher TD Light type F / 360 free swivel type

M o d e l	TDL-120F	TDL-200F
Main body class reference ton	10~14	20~22
Maximum working pressure kgf/cm^2	350	
Main body length A mm	1,970	2,260
Maximum opening width B mm	850	1,100
Wire rod cutter length C mm	130	160
Top crushing force D tonf	57	82
Center crushing force E tonf	87	129
W e i g h t kg	1,180	1,940

※Single two-way hydraulic piping is necessary for type F.※The arm of the power shovel should preferably be reinforced to mount a TOKU series.※It cannot be mounted to power shovels in different classes.

■ Specification table for TOKU Primary Crusher TD Light type S / 360 hydraulic swivel type

M o d e l	TDL-120S	TDL-200S
Main body class reference ton	10~14	20~22
Maximum working pressure kgf/cm^2	350	
Main body length A mm	1,980	2,260
Maximum opening width B mm	850	1,100
Wire rod cutter length C mm	130	160
Top crushing force D tonf	57	82
Center crushing force E tonf	87	126
W e i g h t kg	1,185	1,950

※Double two-way hydraulic piping are necessary for type S (if the back pressure is more than 20kgf/cm^2 , drain piping is necessary). ※The arm of the power shovel should preferably be reinforced to mount a TOKU series. ※cannot be mounted to power shovels of different classes.

■ Specification table for Automatic TOKU Primary Crusher TD Light type A / 360 automatic

M o d e l	TDL-120A	TDL-200A
Main body class reference ton	10~14	20~22
Maximum working pressure kgf/cm^2	350	
Minimum working pressure kgf/cm^2	300	
Main body length A mm	1,970	2,260
Maximum opening width B mm	850	1,100
Wire rod cutter length C mm	130	160
Top crushing force D tonf	57	82
Center crushing force E tonf	87	129
W e i g h t kg	1,200	1,980

※Single two-way hydraulic piping is necessary for Automatic TOKU Primary crusher TD Light. ※Use it above the minimum working pressure of 300kgf/cm^2 . If it is lower than the minimum working pressure, swiveling may be impossible.

Powerful primary concrete crusher TOKU TOKU Primary Crusher

The large cylinder and speed-up valve mean less vibration, less noise, and highly efficient crushing. The crushing claw is made of special forged steel and ensures first-rate durability and maintenance. It is the best for first-stage crushing such as demolition of buildings and foundations, as well as reinforced concrete buildings. There are three types of swivel: free (touch and turn), full-swivel, and automatic. You can select according to your application.



The special steel wire rod cutter allows cutting of reinforced steel rods during concrete crushing. The wire rod cutter is an economical and four-way use type. It exercises its power in first-stage crushing situations such as demolition of buildings and foundations.

You can detach and attach it with two pins, as easily as changing the bucket. Replacement time at your work site is greatly reduced. It is attachable to your current power shovel, and adaptable to fit all sorts of models. If you change your model, simply change the adaptor.

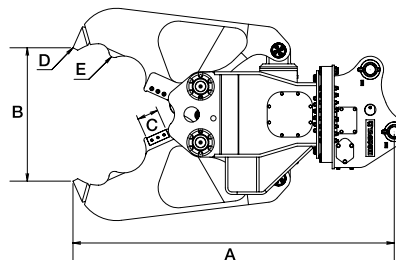

Free swivel type

T-60F
T-120F
T-200F

Hydraulic swivel type

T-60S
T-120S
T-200S

Automatic swivel type

T-60A
T-120A
T-200A

■ Specification table for TOKU Primary Crusher type F /360 free swivel type

Model	T-60F	T-120F	T-200F
Main body class reference :ton	6~8	10~14	20~22
Maximum working pressure :kgf/cm ²	280	350	
Main body length A mm	1,670	2,100	2,410
Maximum opening width B mm	600	850	1,000
Wire rod cutter length C mm	100	120	160
Top crushing force D tonf	40	65	93
Center crushing force E tonf	58	94	132
Weight kg	710	1,370	2,150

※Single two-way hydraulic piping is necessary for type F. ※The arm of the power shovel should preferably be reinforced to mount a TOKU series. ※It cannot be mounted to power shovels in different classes.

■ Specification table for TOKU Primary Crusher type S/360 hydraulic swivel type

Model	T-60S	T-120S	T-200S
Main body class reference :ton	6~8	10~14	20~22
Maximum working pressure :kgf/cm ²	280	350	
Main body length A mm	1,670	2,100	2,410
Maximum opening width B mm	600	850	1,000
Wire rod cutter length C mm	100	120	160
Top crushing force D tonf	40	65	93
Center crushing force E tonf	58	94	132
Weight kg	720	1,390	2,170

※Double two-way hydraulic piping are necessary for type S. (If the back pressure is more than 20kgf/cm², drain piping is necessary.) ※The arm of the power shovel should preferably be reinforced to mount a TOKU series. ※It cannot be mounted to power shovels in different classes.

■ Specification table for automatic TOKU Primary Crusher type A/360 automatic swivel type

Model	T-60A	T-120A	T-200A
Main body class reference :ton	6~8	10~14	20~22
Maximum working pressure :kgf/cm ²	280	350	
Minimum working pressure :kgf/cm ²	250	280	
Main body length A mm	1,670	2,100	2,410
Maximum opening width B mm	600	850	1,000
Wire rod cutter length C mm	100	120	160
Top crushing force D tonf	40	65	93
Center crushing force E tonf	58	94	132
Weight kg	720	1,400	2,170

※Single two-way hydraulic piping is necessary for type A.※ Use it above the minimum working pressure (MF-60A:250kgf/cm², MF-120A/M2-200A: 80kgf/cm²). If it is lower than the minimum working pressure, swiveling may be impossible. ※The arm of the power shovel should preferably be reinforced to mount a TOKU series. ※It cannot be mounted to power shovels in different classes.

Powerful wire rod cutter TOKU PAT

TOKU Cutter

The large cylinder and speed-up valve mean less vibration, less noise, and highly efficient cutting. It strongly supports demolition work of reinforcing rod and steel frame buildings. The compact design using a large cylinder means greater visibility and cutting power. There are three types of swivel: free (touch and turn), full-swivel, and automatic. You can select according to your application.



The tough special steel cutter edge can cut various steel frames and reinforced rod.

You can detach and attach it with two pins, as easily as changing the bucket. Replacement time at your work site is greatly reduced. It is attachable to your current power shovel, and adaptable to fit all sorts of models. If you change your model, simply change the adaptor.

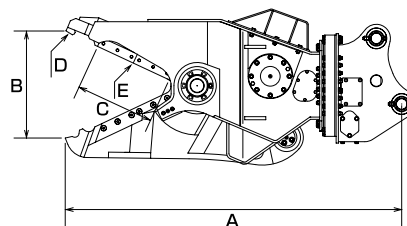

Free swivel type

TC- 60 F
TC-120F
TC-200F

Hydraulic swivel type

TC- 60 S
TC-120S
TC-200S
TC-300S

Automatic swivel type

TC- 40 A
TC- 60 A
TC-120A
TC-200A
TC-300A

■ Specification table for TOKU Cutter type F / 360 free swivel type

Model	TC-60F	TC-120F	TC-200F
Main body class reference ton	6~8	10~14	20~22
Maximum working pressure kgf/cm ²	280	350	
Main body length A mm	1,620	1,950	2,390
Maximum opening width B mm	485	610	760
Wire rod cutter length C mm	320	400	560
Top crushing force D tonf	32	48	76
Center crushing force E tonf	67	101	158
Weight kg	760	1,330	2,210

※Single two-way hydraulic piping is necessary for type F. ※The arm of the power shovel should preferably be reinforced for mounting a TOKU series. ※It cannot be mounted to power shovels in different classes.

■ Specification table for TOKU Cutter type S/360 hydraulic swivel type

Model	TC-60S	TC-120S	TC-200S	TC-300S
Main body class reference ton	6~8	10~14	20~22	30~35
Maximum working pressure kgf/cm ²	280	350		
Main body length A mm	1,620	1,950	2,390	2,850
Maximum opening width B mm	485	610	760	870
Wire rod cutter length C mm	320	400	560	740
Top crushing force D tonf	32	48	76	98
Center crushing force E tonf	67	101	158	190
Weight kg	770	1,350	2,230	3,190

※Double two-way hydraulic piping are necessary for type S. (If the back pressure is more than 20kgf/cm², drain piping is necessary.) ※The arm of the power shovel should preferably be reinforced for mounting a TOKU series. ※It cannot be mounted to power shovels in different classes.

■ Specification table for automatic TOKU Cutter type A/360 automatic swivel type

Model	TC-40A	TC-60A	TC-120A	TC-200A	TC-300A
Main body class reference ton	4~5	6~8	10~14	20~22	30~35
Maximum working pressure kgf/cm ²	250	280	350		
Minimum working pressure kgf/cm ²	190	250	280		
Main body length A mm	1,290	1,620	1,950	2,390	2,760
Maximum opening width B mm	405	485	610	760	870
Wire rod cutter length C mm	240	320	400	560	740
Top crushing force D tonf	13	32	48	76	98
Center crushing force E tonf	28	67	101	158	190
Weight kg	330	770	1,350	2,240	3,100

※Single two-way hydraulic piping is necessary for type A. ※Use it above the minimum working pressure (MP-40A: 190kgf/cm², MP-60A: 250kgf/cm², MP-120A, MP-200A, MP-300A: 280kgf/cm²). If it is lower than the minimum working pressure, swiveling may be impossible. ※The arm of the power shovel should preferably be reinforced for mounting a TOKU series. ※It cannot be mounted to power shovels in different classes.

Powerful reinforcing rod and primary concrete crusher TOKU TOKU FC Cutter

The TOKU cutter is equipped with large cutting teeth. It exercises its power at demolition work reinforcing rod and steel frame buildings and demolition of reinforced concrete buildings. There are three types of swivel: free (touch and turn), full-swivel, and automatic. You can select according to your application.



The tough special steel cutter edge can cut various steel frames and reinforcing rod. The wire rod cutter is an economical and four-way use type. It has a compact design using a large cylinder with good visibility and great cutting power. You can easily operate it while checking the cutting points.

You can detach and attach it with two pins, as easily as changing the bucket. Replacement time at your work site is greatly reduced. It is attachable to your current power shovel, and adaptable to fit all sorts of models. If you change your model, simply change the adaptor.

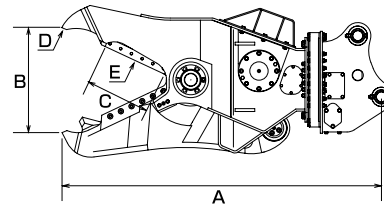

Free swivel type
TCF-60F
TCF-120F
TCF-200F

Hydraulic swivel type
TCF-60S
TCF-120S
TCF-200S

Automatic swivel type
TCF-60A
TCF-120A
TCF-200A

■ Specification table for TOKU FC Cutter type F/360 free swivel type

Model	TCF-60F	TCF-120F	TCF-200F
Main body class reference ton	6~8	10~14	20~22
Maximum working pressure kgf/cm ²	280	350	
Main body length A mm	1,650	2,230	2,440
Maximum opening width B mm	510	675	800
Wire rod cutter length C mm	320	400	500
Top crushing force D tonf	31	43	72
Center crushing force E tonf	67	101	169
Weight kg	760	1,340	2,250

※Single two-way hydraulic piping is necessary for type F. ※The arm of the power shovel should preferably be reinforced for mounting a TOKU series. ※It cannot be mounted to power shovels in different classes.

■ Specification table for TOKU FC Cutter type S/360 hydraulic swivel type

Model	TCF-60S	TCF-120S	TCF-200S
Main body class reference ton	6~8	10~14	20~22
Maximum working pressure kgf/cm ²	280	350	
Main body length A mm	1,650	2,230	2,440
Maximum opening width B mm	510	675	800
Wire rod cutter length C mm	320	400	500
Top crushing force D tonf	31	43	72
Center crushing force E tonf	67	101	169
Weight kg	770	1,360	2,270

※Double two-way hydraulic pipings are necessary for type S. (If the back pressure is more than 20kgf/cm², drain piping is necessary.) ※The arm of the power shovel should preferably be reinforced for mounting a TOKU series. ※It cannot be mounted to power shovels in different classes.

■ Specification table for automatic TOKU FC Cutter type A/360 auto-swivel type

Model	TCF-60A	TCF-120A	TCF-200A
Main body class reference ton	6~8	10~14	20~22
Maximum working pressure kgf/cm ²	280	350	
Minimum working pressure kgf/cm ²	250	280	
Main body length A mm	1,650	2,230	2,440
Maximum opening width B mm	510	675	800
Wire rod cutter length C mm	320	400	500
Top crushing force D tonf	31	43	72
Center crushing force E tonf	67	101	169
Weight kg	780	1,370	2,280

※Single two-way hydraulic piping is necessary for type A. ※Use it above the minimum working pressure (MFP-60A: 250kgf/cm², MFP-120A, MFP-200A: 280kgf/cm²). If it is lower than the minimum working pressure, swiveling may be impossible. ※The arm of the power shovel should preferably be reinforced for mounting a TOKU series. ※It cannot be mounted to power shovels in different classes.

Mini shovel twin cylinder primary crusher

Mini TOKU TDF-10

Hydraulic swivel type
TDF-10S
Automatic swivel type
TDF-10A

The mini TOKU TDF-10 is a mini shovel primary crusher featuring a twin cylinder in 1-ton class models. Compact in size, its powerful twin cylinder displays dynamite power! It is the primary crusher suitable for crushing work in limited spaces.

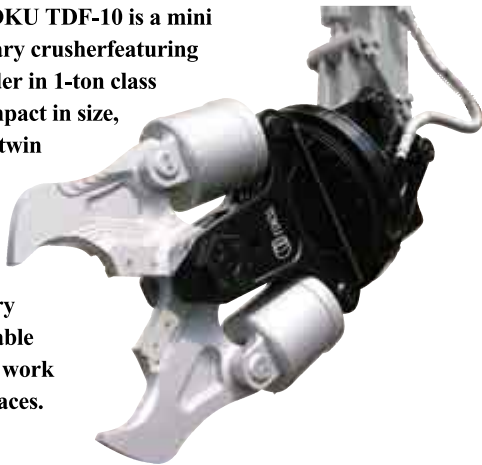

Original shape arm and original shape reinforced steel rod cutter of Standard Equipment for mini TOKU TDF-10.

It is best for narrow and small sites. The standard equipment reinforced steel rod cutter made of special steel permits easy separating and collecting work. You can detach and attach it with two pins, as easily as changing the bucket. Replacement time at your work site is greatly reduced. It is an adaptor type which fits all sorts of models. If you change your model, simply change the adaptor.

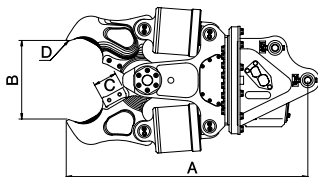

■ Specification table for Mini TOKU TDF-10 type S/type A

M o d e l	TDF-10S	TDF-10A
Main body class reference ton	1~1.5	
Maximum working pressure tgf/cm ²	210	
Minimum working pressure tgf/cm ²	—	150
Main body length A mm	814	
Maximum opening width B mm	265	
Wire rod cutter length C mm	80	
Top crushing force D tonf	21	
W e i g h t kg	115	

※Double two-way hydraulic piping are necessary for type S (if the back pressure is more than 20kgf/cm², drain piping is necessary.) ※Single two-way hydraulic piping is necessary for type A. ※Use it above the minimum working pressure of 150kgf/cm² for type A. If it is lower than the minimum working pressure, swiveling may be impossible. ※The arm of the power shovel should preferably be reinforced to mount a TOKU series. ※cannot be mounted to power shovels of different classes.

Automatic turning without piping!? No touch and turn? Automatic mechanism

The automatic can make crushing, cutting, and swivel positioning by a simple right-leg pedal control.

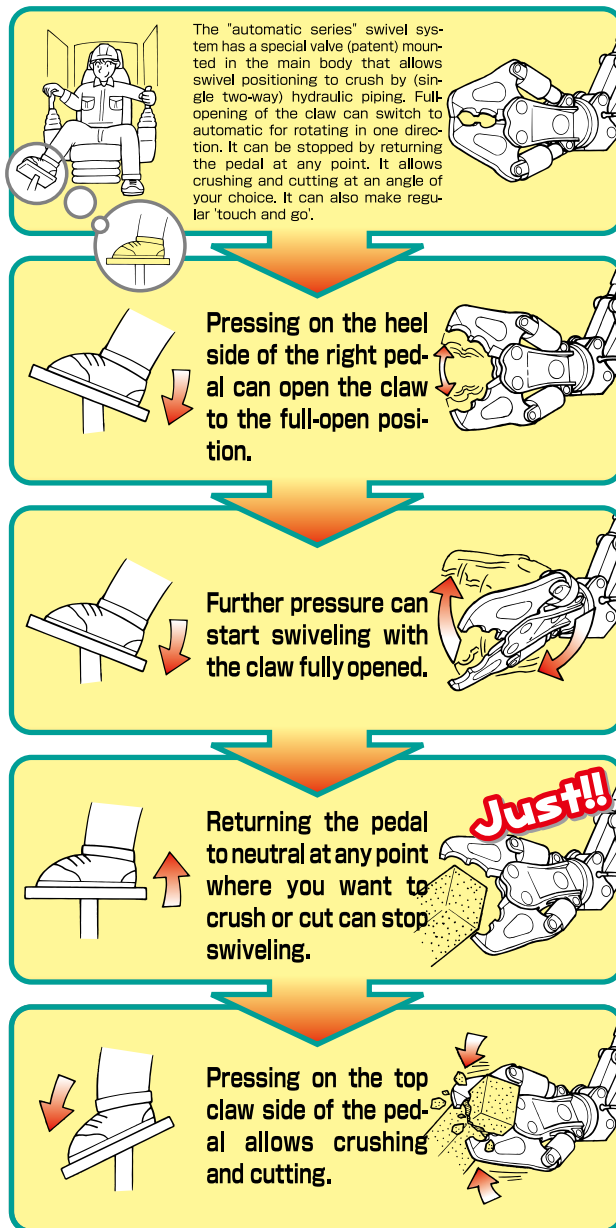

The automatic series fully support various demolition work at all sites "cutting and turning" and "crushing and turning."

Powerful concrete pulverizer

TOKU Pulverizer

The large cylinder and speed-up valve mean less vibration, less noise, and highly efficient cutting. The crushing claw is made of special forged steel. Because it always exercises full crushing power, its good crushing efficiency and low vibration won't cause stress to operators.



The standard equipment special steel wire rod cutter allows cutting of reinforced steel

rods during concrete crushing. The wire rod cutter is an economical and four-way use type. It exercises its power in first-stage crushing situations such as demolition of buildings and foundations.

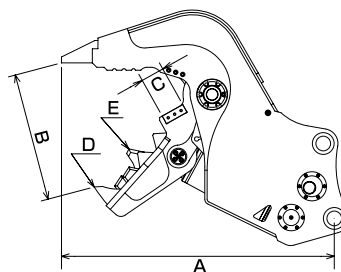

Replacement time can be greatly reduced by detaching and attaching it with two pins, as easily as changing the bucket. A full lineup from mini-type to large type are available. They will your various needs for customers requirements.

■ Specification table for TOKU Pulverizer

Model	TM-40	TM-60	TM-120	TM-200	TM-300
Main body class reference ton	4~5	6~8	10~14	20~22	30~35
Maximum working pressure kgf/cm^2	250	280	350		
Main body length A mm	970	1,285	1,605	1,855	2,370
Maximum opening width B mm	420	600	745	880	940
Wire rod cutter length C mm	70	100	120	160	180
Top crushing force D tonf	17	35	51	75	86
Cutter center cutting force E tonf	24	51	76	110	125
Weight kg	235	550	1,010	1,680	2,750

*Single two-way hydraulic piping is necessary for the TOKU pulverizer. *The arm of the power shovel should preferably be reinforced for mounting a TOKU series. *It cannot be mounted to power shovels in different classes.

TM- 4 0
TM- 6 0
TM-120
TM-200
TM-300

Magnet TOKU pulverizer

Magnet TOKU Pulverizer

TM-120M
TM-200M

The TOKU pulverizer is equipped with a magnet!! Along with its original small crushing performance, it can efficiently collect reinforced rod during secondary crushing of separated re-use.



Only this machine is capable of performing concrete crushing, reinforced rod separation and collection work. The forcible release function by reverse excitation allows highly efficient magnet work. Because the magnet power uses the hydraulic shovel's battery, no additional dynamo is necessary. The powerful magnet aids collection of every small scrap of iron. Also, the magnet's housing can minimize magnet wear.

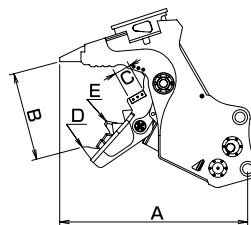

■ Specification table for magnet TOKU Pulverizer

Model	TM-120M	TM-200M
Main body class reference ton	10~14	20~22
Maximum working pressure kgf/cm^2	350	
Main body length A mm	1,605	1,855
Maximum opening width B mm	745	880
Wire rod cutter length C mm	120	160
Top crushing force D tonf	51	75
Cutter center cutting force E tonf	76	110
Magnet	Power source	BatteryDC24V
	Use rating	60%ED
	Diameter : mm	∅500
Weight kg	1,350	2,070

*Single two-way hydraulic piping is necessary for the magnet TOKU pulverizer. *The arm of the power shovel should preferably be reinforced for mounting a TOKU series. *It cannot be mounted to power shovels in different classes. *Use it in an alternator mounting machine of more than 50A.

Grasper V3

GRASPER V3

Your power shovel can do grip work. The grasper series with its trust and superior record is best for various grip work. The grasper V3 has the original link mechanism and user-friendly opening width.

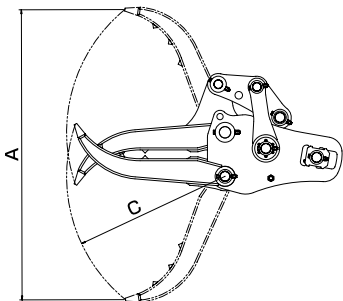
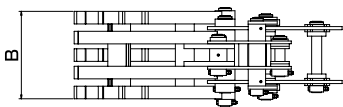
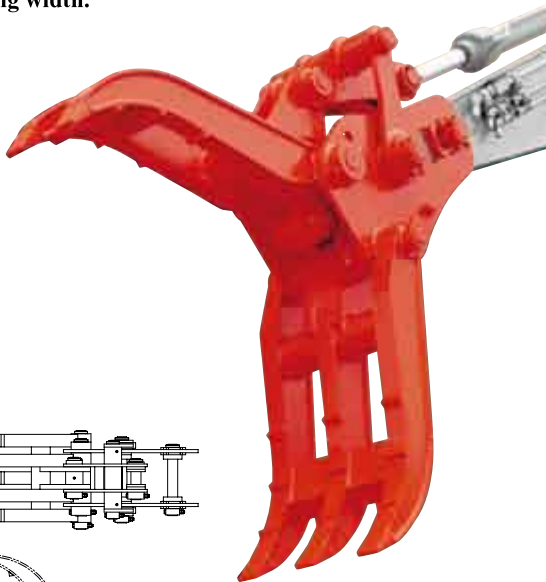

Have you ever heard these complaints while using a grasper? "The arm is bent.," or "The attachment pin is broken.," The Grasper V3 has adapted our original link mechanism. In addition to its regular gripping function, it reduces the risk of damage to the arm and fixing pins. Compared with two-point mounting graspers, the arm and fixing pins are exposed to minimum stress.

GT- 0 8
GT- 1 5
GT- 3 0
GT- 4 0
GT- 6 0
GT-120
GT-200
GT-300
GT-400

Technical Note

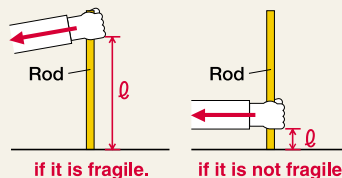

Why is the arm fragile? As shown in the above figure, the bigger the length l is, the more fragile the rod is.

It is the best for demolition work of wooden buildings. This machine is enough for scrap wood separation and loading after demolition!! Heavy scraps and sharp metal bits can be handled so that safe work can be expected with minimum operators.

The bucket operation itself can be converted to grasping operation. Because of its mechanical type, hydraulic piping is unnecessary. Powerful grasping force will permit moving and loading without dropping items once grasped. It is attachable to all sorts of models. If you change your model, simply change the adaptor. A full lineup of models ranging from mini-shovel to large shovel along with the standard type are available.

- *1. Some models are not prepared with an adaptor type.
- *2. It cannot be mounted to power shovels in different classes.



Grasper V3 forwarding position

■ Specification table for Grasper V3

Model	GT-08	GT-15	GT-30	GT-40	GT-60	GT-120	GT-200	GT-300	GT-400	
Main body class reference ton	0.7~1.5	1.2~3	3~4	4~5	6~8	10~14	20~22	30~35	40~45	
Maximum opening width A mm	820	1,020	1,220	1,405	1,680	1,910	2,305	2,665	2,930	
Claw width B mm	230	270	330	425	470	560	695	830	910	
Claw length C mm	440	545	650	760	905	1,030	1,260	1,440	1,585	
Weight kg	60	110	160	220	370	610	1,130	1,860	2,400	
Adaptor type	○							×		

*The claws of GT-08, GT-15, and GT-30 do not have a box structure. *For mounting of Grasper V3, GT-200 to *The arm of the power shovel needs to be reinforced to mount grasper V3, GT-08, GT-15, GT-30, The arm of the

1.0m³(former JIS0.9m³), the specifications of GT-200 differs according to the model. Please ask for our staff. power shovel should preferably be reinforced to mount the other grasper V3 series to prevent arm damage.



GV-03
GV-05
GV-10
GV-20
GV-30
GV-40
GV-70

By request, our original standard grasper, the powerful Grasper V has returned!! Our best-selling machine with faithful fans and an excellent performance record, the original powerful Grasper V set a new standard for gripping machines.

Our best-selling original grasping machine, "Powerful Grasper V". The arm and pins can't be broken or bend. The gasping force is especially strong.

Our original guide-link mechanism of Grasper V has the following special features:

Special feature 1: The bucket cylinder is always operated in parallel with and linear to the arm.

Special feature 2: Direct movement is possible at a point close to the arm.

These features can prevent damage of the arm and fixing pins better than the regular 2-point mounting models.

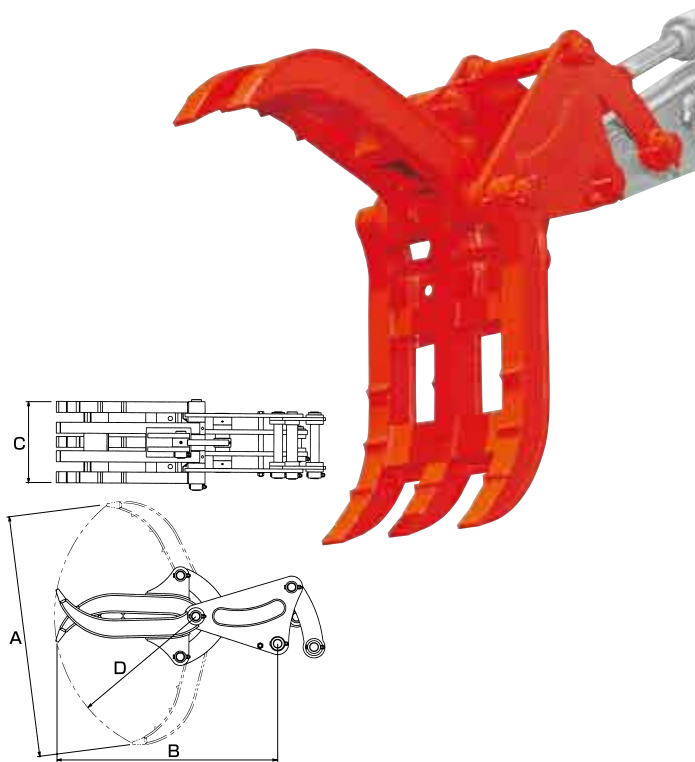

■ Specification table for Powerful Grasper V

Model	GV-03	GV-05	GV-10	GV-20	GV-30	GV-40	GV-70
Main body class reference ton	0.7~1.5	1.2~3	3~4	4~5	6~8	10~14	20~22
Maximum opening width A mm	700	830	1,050	1,250	1,450	1,700	2,050
Main body length B mm	655	825	970	1,100	1,270	1,530	1,930
Claw width C mm	235	277	334	460	470	575	700
Claw length D mm	420	520	620	720	820	980	1,200
Weight kg	50	115	160	240	380	540	1,250
Adaptor type	X				O		

*The claw of GV-03, GV-05, and GV-10 do not have a box structure. *The arm of the power shovel needs to be reinforced for mounting Grasper V. *The arm of the power shovel should preferably be reinforced to mount the other grasper V series to prevent

arm damage.

TILT TYPE swing grasper

GRASPER VL

GV-15L
GV-30L
GV-40L
GV-60L
GV-120L
GV-200L
GV-300L
GV-400L

An additional swing function permits grasping work from every angle. The fixed type model allows excellent work efficiency at challenging sites.

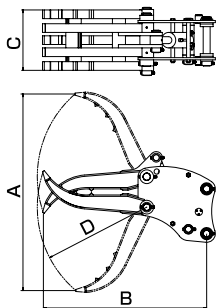

The hydraulic cylinder mounted in the main body controls claw opening/closing operations. Smooth work can be obtained by changing bucket operation to swing operation.

The swing operation allows free change in its grasping angle. Single two-way hydraulic piping is necessary. Replacement time can be reduced by detaching and attaching it with two pins, as easily as changing the bucket.

■ Specification table for Swing Grasper VL

Model	GV-15L	GV-30L	GV-40L	GV-60L	GV-120L	GV-200L	GV-300L	GV-400L
Main body class reference ton	1,2~3	3~4	4~5	6~8	10~14	20~22	30~35	40~45
Maximum working pressure kgf/cm ²	210	250	280	350				
Maximum opening width A mm	960	1,200	1,305	1,665	1,855	2,260	2,535	2,815
Main body length B mm	900	1,020	1,160	1,360	1,575	1,880	2,130	2,340
Claw width C mm	270	330	425	470	560	695	830	910
Claw length D mm	545	660	760	905	1,030	1,260	1,440	1,585
Weight kg	110	140	230	370	570	1,080	1,760	2,430

*The claw of GV-15L and GV-30L do not have a box structure. *Hydraulic piping to main body is necessary separately. *The arm of the power shovel should preferably be reinforced to mount Swing grasper VL series to prevent arm damage.

Magnet swing grasper

GV-120LM
GV-200LM

Mag net GRASPER

A magnet is mounted to the swing grasper!! Now selection and loading work of waste plastic and scraps is possible.

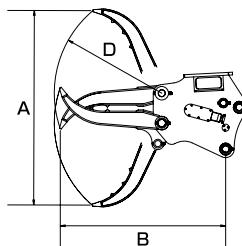

The magnet-mounted grasper powerfully supports various selection and loading work. The forcible release function by reverse excitation allows highly efficient magnet work. Because the magnet power uses the hydraulic shovel's battery, no additional dynamo is necessary. The powerful magnet can aid in collecting every small scrap of iron. The magnet's housing can minimize magnet wear.

■ Specification table for Magnet Swing Grasper

Model	GV-120LM	GV-200LM
Main body class reference ton	10~14	20~22
Maximum working pressure kgf/cm ²	350	
Maximum opening width A mm	1,850	2,280
Main body length B mm	1,660	1,940
Claw width C mm	560	695
Claw length D mm	1,030	1,260
Magnet	Power source	BatteryDC24V
	Use rating	60%ED
	Diameter : mm	∅ 500
Weight kg	870	1,430

*Hydraulic piping to the main body is necessary separately. *Use it in an alternator mounting machine of more than 50A.

Rock grasper R GRASPER^R

GR-120
GR-200
GR-300
GR-400

This machine has an original link mechanism. The claw is shaped to grasp big stones and rocks. A special salient laid inside the claw helps grasp securely.

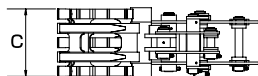

Such operations as loading and carrying big stones and rocks can be conducted safely and comfortably.

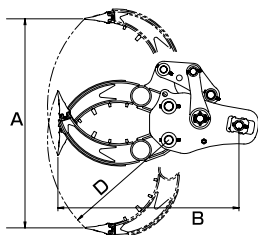

The swing operation allows free The conventional style of crane work after slinging can be conducted only by this power shovel. The top of the claw mounts to the point normally used in buckets. Durability has been improved by an additional reinforcer to the whole claw.

■ Specification table for Rock Grasper R

Model	GR-120	GR-200	GR-300	GR-400
Main body class reference ton	10~14	20~22	30~35	40~45
Maximum opening width A mm	1,775	2,170	2,530	2,660
Main body length B mm	1,690	2,085	2,490	2,680
Claw width C mm	560	700	825	910
Claw length D mm	1,030	1,260	1,440	1,585
Weight kg	700	1,350	2,170	3,150
Adaptor type	○		×	

*The arm of the power shovel should preferably be reinforced for mounting a rock grasper R series to prevent arm damage.

Rock swing grasper RL GRASPER^{RL}

GR-120L
GR-200L
GR-300L
GR-400L

The swing function allows a wider work space. Loading and carrying big stones and rocks can be conducted safely and comfortably.

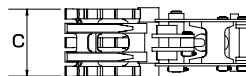
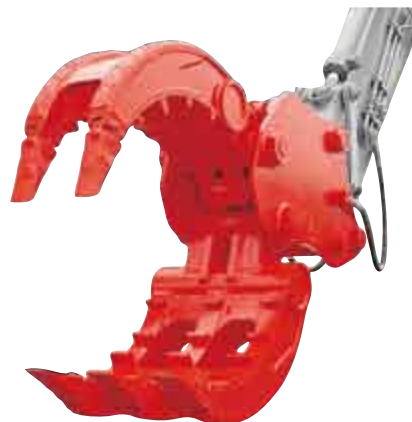

Slight angle adjustment and movement is possible in loading and carrying big stones and rocks.

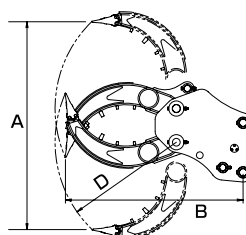

Swinging and grasping in bucket operations are controlled by one foot pedal. Single two-way piping is necessary as hydraulic piping for the grasping operation. Replacement time can be greatly reduced by detaching and attaching it with two pins, as easily as changing the bucket.

■ Specification table for Rock Swing Grasper RL

Model	GR-120L	GR-200L	GR-300L	GR-400L
Main body class reference ton	10~14	20~22	30~35	40~45
Maximum working pressure kgf/cm ²	350			
Maximum opening width A mm	1,710	2,160	2,390	2,655
Main body length B mm	1,540	1,950	2,210	2,480
Claw width C mm	560	695	825	910
Claw length D mm	1,030	1,260	1,440	1,585
Weight kg	740	1,340	2,140	3,070

*Hydraulic piping to the main body is necessary separately. *The arm of the power shovel should preferably be reinforced for mounting a rock swing grasper RL series to prevent arm damage.

Total swivel (360°) GRASPER VS

It features a 360° total swivel function. Swing and total swivel permit grasping in every orientation. The swivel operation while grasping ensures high efficient work.

GV-15S
GV-30S
GV-40S
GV-60S
GV-120S
GV-200S
GV-300S
GV-400S

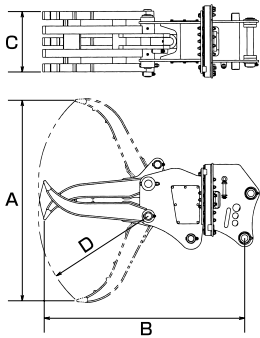
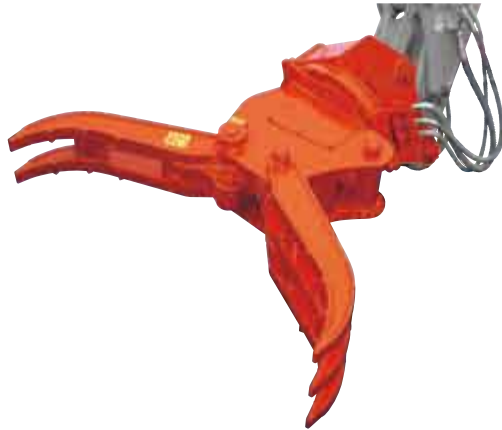

It is quite useful as a material handling machine. Loading of long items is possible regardless of work posture.

One foot pedal controls the grasping operation and the other foot pedal the swivel operation. Double two-way hydraulic piping is necessary for grasping and swiveling, respectively. Hydraulic motor damage will be minimized thanks to the hydraulic valve mounted in the main body.

■ Specification table for Total Swivel Grasper VS

Model	GV-15S	GV-30S	GV-40S	GV-60S	GV-120S	GV-200S	GV-300S	GV-400S
Main body class reference ton	1,2~3	3~4	4~5	6~8	10~14	20~22	30~35	40~45
Maximum working pressure kgf/cm ²	250		280		350			
Maximum opening width A mm	820	1,200	1,305	1,670	1,855	2,265	2,540	2,815
Main body length B mm	1,015	1,275	1,430	1,700	1,880	2,255	2,510	2,875
Claw width C mm	250	330	425	470	560	695	830	910
Claw length D mm	500	660	760	905	1,030	1,260	1,440	1,585
Weight kg	100	180	310	510	800	1,460	2,200	3,350

*Double two-way hydraulic piping to the main body is necessary (Drain piping is necessary for 300S, 400S and main body with its back pressure being more than 20kgf/cm².) * The arm of the power shovel should preferably be reinforced for mounting the total swivel grasper VS series to prevent arm damage.

Total swivel (360°) Timber GRASPER

GW-30S
GW-40S
GW-60S
GW-120S
GW-200S

A swing & total swivel type grip machine specialized for forestry. Timber at every angle can be securely gripped. It can be applied to disaster recovery work such as removal of randomly stacked wood and fallen trees.

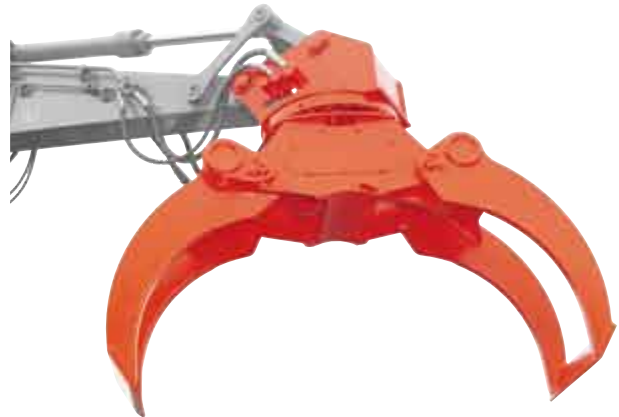

High torque, 360° total swivel permits smooth collection, disposal and loading work while swiveling with timber.

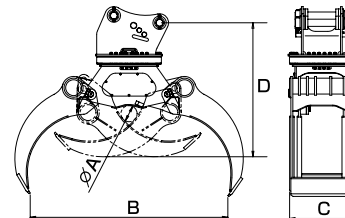

The shape of the ripper permits secure holding-armload style-and minimizes scratches to timber. The hydraulic valve housed in the main body can prevent hydraulic motor damage. Loading long items is possible regardless of work posture.*

■ Specification table for Total Swivel Timber Grasper

Model	GW-30S	GW-40S	GW-60S	GW-120S	GW-200S
Main body class reference ton	3~4	4~5	6~8	10~14	20~22
Maximum working pressure kgf/cm ²	250		280	350	
Minimum grasping diameter A mm	100	100	100	130	180
Maximum opening width B mm	1,010	1,120	1,230	1,830	2,200
Claw width C mm	315	405	490	610	720
Total height D mm	815	875	975	1,270	1,490
Weight kg	160	250	440	830	1,220

*Double two-way piping is separately necessary for hydraulic piping to the main body. (Drain piping is necessary for the main machine with its back pressure being more than 20kgf/cm².) * The arm of the power shovel should preferably be reinforced for mounting all swivel timber grasper series to prevent arm damage.
* Since extreme one-ended grasping is very dangerous, please refrain from it.

GRASPER series

Bucket & Fork

BF- 3 0
BF- 4 0
BF- 6 0
BF-120
BF-200
BF-220

Bucket scooping function and fork grabbing function are combined in this unit. Fork grabbing in the holding position can prevent dropping, making it more efficient than working with only a bucket.

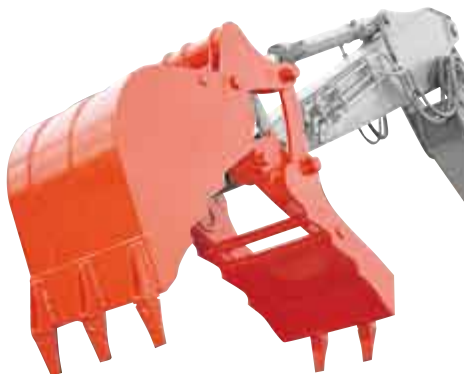

Excellent for disposal of waste soil in housing demolition and civil engineering waste collection and loading/excavating work. It is also useful for relatively small and numerous items.

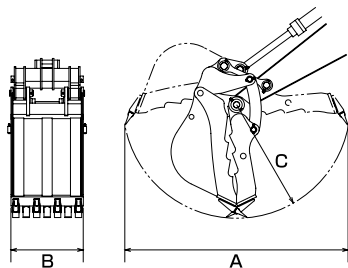

Because the bucket and fork are closed, it can grip small items. It is best for handling work such as root cutting and wood chip collection in forestry. The bucket operation itself becomes a grip operation. It's a mechanical type so hydraulic piping is unnecessary.

■ Specification table for Bucket & Fork

M o d e l	BF-30	BF-40	BF-60	BF-120	BF-200	BF-220
Main body class reference ton	3~4	4~5	6~8	10~14	20~22	22~24
Maximum opening width A mm	1,520	1,825	1,995	2,365	2,770	2,870
Claw width B mm	425	535	575	680	900	945
Claw length C mm	730	875	1,020	1,205	1,405	1,470
Weight kg	200	290	410	720	1,340	1,440
Bucket capacity (pileup) m ³	0.05	0.11	0.17	0.3	0.57	0.69
Teeth quantity	5			7		

*The arm of the power shovel needs to be reinforced for mounting a Bucket & Fork : BF-30, BF-40. The arm of the power shovel should preferably be reinforced to mount the other grasper V3 series to prevent arm damage. The arm of the power shovel should preferably be reinforced to mount other Bucket & Fork series to prevent arm damage. Carry posture is possible while it is mounted. *The claw length means the dimension of the main bucket.

GRASPER series

Orange Bucket

Orange type
ARG-2200
ARG-2300
ARG-2600
ARG-2900
 Fork type
ARP-2200
ARP-2300
ARP-2600
ARP-2900

Orange bucket. These hold strongly and securely grasp up scrap disposal in various loading and unloading work.



Orange type

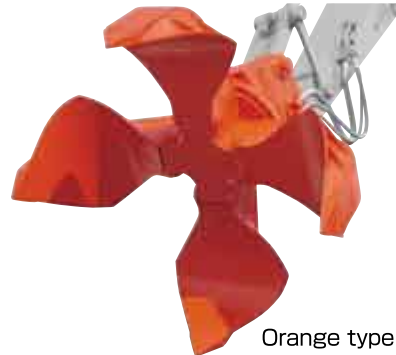

Orange type

First in the industry! Complete sealing prevents failure of and damage to the cylinder hose by chips during scrap work.

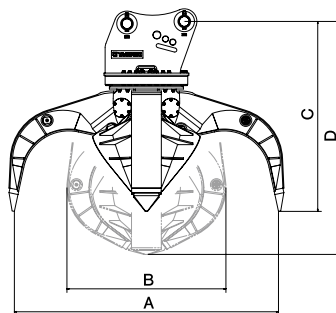

The orange bucket were born from the grip machine standard "grasper series". The orange bucket strongly holds and grasps up plenty of small to medium sized chips and holds medium to large sized chips. Both are powerful buckets.

■ Specification table for Orange Bucket

M o d e l	ARG-2200 <ARP-2200>	ARG-2300 <ARP-2300>	ARG-2600 <ARP-2600>	ARG-2900 <ARP-2900>
Main body class reference ton	20~22	22~25	30~35	
Maximum working pressure kgf/cm ²	350			
Maximum opening width A mm	2,200	2,300	2,600	2,900
Total width B mm	1,380	1,390	1,720	1,750
Total height	(open time) C mm	1,630	1,660	1,950
	(close time) D mm	1,960	2,030	2,330
Weight (including lifting metal) kg	1,760	1,850	2,640	2,800
	<1,700>	<1,780>	<2,550>	<2,690>

*ARG is orange type, ARP is fork type, *Descriptions in parentheses are the specification standards of the fork type, *The specification drawing is of the orange type.

Original Powerful Grasper

■ Type H (attached with reinforcer)

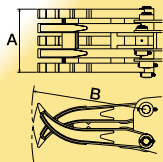

Relevant model	GT-40 GV-40L GV-40S	GT-60 GV-60L GV-60S	GT-120 GV-120L GV-120S	GT-200 GV-200L GV-200S
Claw width A (mm)	425	470	560	695
Claw length B (mm)	760	905	1,030	1,260

■ Type HD (attached with reinforcer, point type)

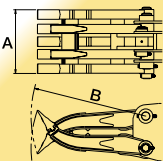

Relevant model	GT-40 GV-40L GV-40S	GT-60 GV-60L GV-60S	GT-120 GV-120L GV-120S	GT-200 GV-200L GV-200S
Claw width A (mm)	425	470	560	695
Claw length B (mm)	760	905	1,080	1,260

■ Type T (long)

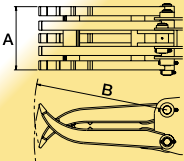

Relevant model	GT-40 GV-40L GV-40S	GT-60 GV-60L GV-60S	GT-120 GV-120L GV-120S	GT-200 GV-200L GV-200S
Claw width A (mm)	425	470	560	695
Claw length B (mm)	850	1,005	1,180	1,460

■ Type RS (ripper R shape [small])

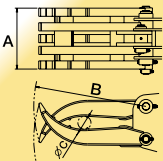

Relevant model	GT-40 GV-40L GV-40S	GT-60 GV-60L GV-60S	GT-120 GV-120L GV-120S	GT-200 GV-200L GV-200S
Claw width A (mm)	425	470	560	695
Claw length B (mm)	760	905	1,030	1,260
Minimum grippiness C (mm)	∅90	∅100	∅120	∅150

■ Type RM (ripper R shape [middle])

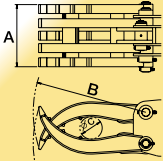

Relevant model	GT-40 GV-40L GV-40S	GT-60 GV-60L GV-60S	GT-120 GV-120L GV-120S	GT-200 GV-200L GV-200S
Claw width A (mm)	425	470	560	695
Claw length B (mm)	760	905	1,030	1,260
Minimum grippiness C (mm)	∅150	∅170	∅210	∅250

■ Type RL (ripper R shape [large], attached with reinforcer)

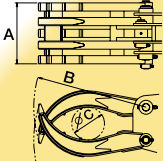

Relevant model	GT-40 GV-40L GV-40S	GT-60 GV-60L GV-60S	GT-120 GV-120L GV-120S	GT-200 GV-200L GV-200S
Claw width A (mm)	425	470	560	695
Claw length B (mm)	760	905	1,030	1,260
Minimum grippiness C (mm)	∅210	∅240	∅300	∅350

Customizing Grasper (grasping machine) with an optional special claw!!

In response to our customers' special requests, we offer special claws in optional specifications. You can select a grasper with an optional claw in special specifications according to your needs from a wide variety of choices.

■ Type N3

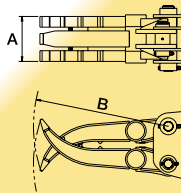

Relevant model	GT-40 GV-40L GV-40S	GT-60 GV-60L GV-60S	GT-120 GV-120L GV-120S	GT-200 GV-200L GV-200S
Claw width A (mm)	240	285	335	420
Claw length B (mm)	760	905	1,030	1,260

■ Type H3 (attached with reinforcer)

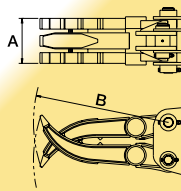

Relevant model	GT-40 GV-40L GV-40S	GT-60 GV-60L GV-60S	GT-120 GV-120L GV-120S	GT-200 GV-200L GV-200S
Claw width A (mm)	240	285	335	420
Claw length B (mm)	760	905	1,030	1,260

■ Type HD3 (attached with reinforcer, point type)

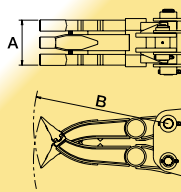

Relevant model	GT-40 GV-40L GV-40S	GT-60 GV-60L GV-60S	GT-120 GV-120L GV-120S	GT-200 GV-200L GV-200S
Claw width A (mm)	240	285	335	420
Claw length B (mm)	760	905	1,080	1,260

■ Type T3 (long)

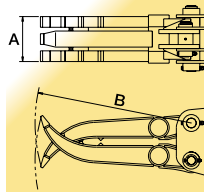

Relevant model	GT-40 GV-40L GV-40S	GT-60 GV-60L GV-60S	GT-120 GV-120L GV-120S	GT-200 GV-200L GV-200S
Claw width A (mm)	240	285	335	420
Claw length B (mm)	850	1,005	1,180	1,460

■ Type RL3 (ripper R shape [large], attached with reinforcer)

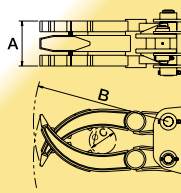

Relevant model	GT-40 GV-40L GV-40S	GT-60 GV-60L GV-60S	GT-120 GV-120L GV-120S	GT-200 GV-200L GV-200S
Claw width A (mm)	240	285	335	420
Claw length B (mm)	760	905	1,030	1,260
Minimum grippiness C (mm)	∅210	∅240	∅300	∅350

Optional special claw selections!!

You can select an original grasper for your application!!

■ Type N7

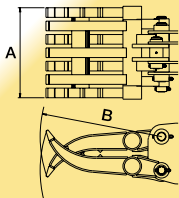

Relevant model	GT-40 GV-40L GV-40S	GT-60 GV-60L GV-60S	GT-120 GV-120L GV-120S	GT-200 GV-200L GV-200S
Claw width A (mm)	520	630	725	935
Claw length B (mm)	760	905	1,030	1,260

■ Type H7 (attached with reinforcer)

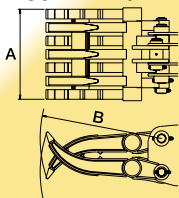

Relevant model	GT-40 GV-40L GV-40S	GT-60 GV-60L GV-60S	GT-120 GV-120L GV-120S	GT-200 GV-200L GV-200S
Claw width A (mm)	520	630	725	935
Claw length B (mm)	760	905	1,030	1,260

■ Type HD7 (attached with reinforcer, point type)

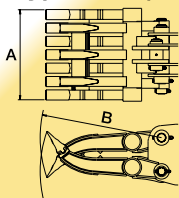

Relevant model	GT-40 GV-40L GV-40S	GT-60 GV-60L GV-60S	GT-120 GV-120L GV-120S	GT-200 GV-200L GV-200S
Claw width A (mm)	520	630	725	935
Claw length B (mm)	760	905	1,080	1,260

■ Type T7 (long)

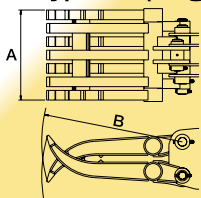

Relevant model	GT-40 GV-40L GV-40S	GT-60 GV-60L GV-60S	GT-120 GV-120L GV-120S	GT-200 GV-200L GV-200S
Claw width A (mm)	520	630	725	935
Claw length B (mm)	850	1,005	1,180	1,460

■ Type RL7 (ripper R shape [large], attached with reinforcer)

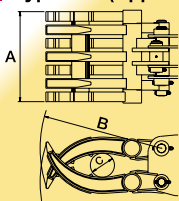

Relevant model	GT-40 GV-40L GV-40S	GT-60 GV-60L GV-60S	GT-120 GV-120L GV-120S	GT-200 GV-200L GV-200S
Claw width A (mm)	520	630	725	935
Claw length B (mm)	760	905	1,030	1,260
Minimum grip diameter C (mm)	∅210	∅240	∅300	∅350

■ Type N6

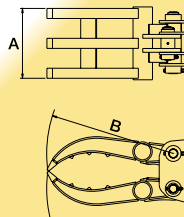

Relevant model	GT-40 GV-40L GV-40S	GT-60 GV-60L GV-60S	GT-120 GV-120L GV-120S	GT-200 GV-200L GV-200S
Claw width A (mm)	425	470	560	695
Claw length B (mm)	760	905	1,030	1,260

■ Type H6 (attached with reinforcer)

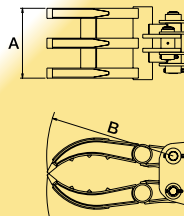

Relevant model	GT-40 GV-40L GV-40S	GT-60 GV-60L GV-60S	GT-120 GV-120L GV-120S	GT-200 GV-200L GV-200S
Claw width A (mm)	425	470	560	695
Claw length B (mm)	760	905	1,030	1,260

■ Type T6 (long)

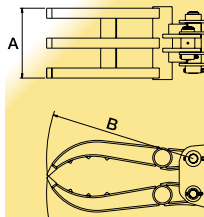

Relevant model	GT-40 GV-40L GV-40S	GT-60 GV-60L GV-60S	GT-120 GV-120L GV-120S	GT-200 GV-200L GV-200S
Claw width A (mm)	425	470	560	695
Claw length B (mm)	850	1,005	1,180	1,460

■ Type HB (waste plastic handling)

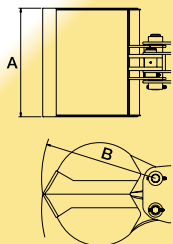

Relevant model	GT-40 GV-40L GV-40S	GT-60 GV-60L GV-60S	GT-120 GV-120L GV-120S	GT-200 GV-200L GV-200S
Claw width A (mm)	700	800	1,000	1,200
Claw length B (mm)	760	890	1,010	1,235

GRASPER *Special Claw*

■ N9

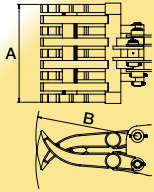

Relevant model	GT-60 GV-60L GV-60S	GT-120 GV-120L GV-120S	GT-200 GV-200L GV-200S
Claw width A (mm)	820	940	1,210
Claw length B (mm)	905	1,030	1,260

■ H9 (attached with reinforcer)

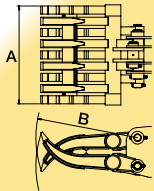

Relevant model	GT-60 GV-60L GV-60S	GT-120 GV-120L GV-120S	GT-200 GV-200L GV-200S
Claw width A (mm)	820	940	1,210
Claw length B (mm)	905	1,030	1,260

■ HD9 (attached with reinforcer, point type)

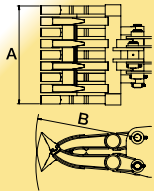

Relevant model	GT-60 GV-60L GV-60S	GT-120 GV-120L GV-120S	GT-200 GV-200L GV-200S
Claw width A (mm)	820	940	1,210
Claw length B (mm)	905	1,080	1,260

■ T9 (long)

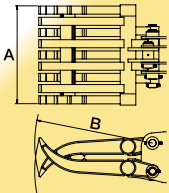

Relevant model	GT-60 GV-60L GV-60S	GT-120 GV-120L GV-120S	GT-200 GV-200L GV-200S
Claw width A (mm)	820	940	1,210
Claw length B (mm)	1,005	1,180	1,460

■ RL9 (ripper R shape [large], attached with reinforcer)

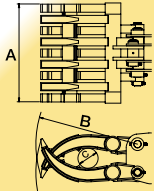

Relevant model	GT-60 GV-60L GV-60S	GT-120 GV-120L GV-120S	GT-200 GV-200L GV-200S
Claw width A (mm)	820	940	1,210
Claw length B (mm)	905	1,030	1,260
Minimum gripper diameter C (mm)	∅240	∅300	∅350

Customizing Grasper (grasping machine) with an optional special claw!!

In response to our customers' special requests, we offer special claws in optional specifications. You can select a grasper with an optional claw in special specifications according to your needs from a wide variety of choices.

■ How to order a special claw model

For your order of a grasper with a special claw in optional specifications, check the model in the following method and order your choice.

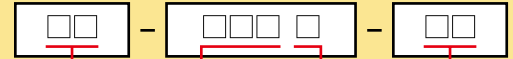

Model

GT
GV

Working Style

No symbol: Mechanical type

L : Tilt type

S : Total swivel type

Class

40 : 4~5ton
60 : 6~8ton
120 : 10~14ton
200 : 20~22ton

Special claw shape

H : 2-3pcs attached with reinforcer
HD : 2-3pcs attached with reinforcer, point type
T : 2-3pcs long
Others

Example: If you order 3-4pcs attached with reinforcer for a 20-ton class swing grasper:

GV - 200 L - H7

※ Shovels more than 30 tons are dealt with separately. Please make an inquiry.



Bucket Crusher

The waste concrete disposal bucket can perform waste concrete disposal work such as scooping, crushing, and stacking with only one hydraulic shovel. Original eccentric crushing teeth and crush bar operate continuously.



Large pieces of waste concrete are held by the crush bar and undergo first crushing. The two eccentrically rotating crushing teeth cut concrete into pieces less than 40mm.

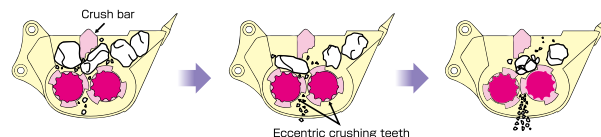

This unit realizes disposal just as a big crusher does without the need for a wide space. Attached to a shovel, it can start concrete waste disposal work. The crushing teeth are made of special forged steel. One point grease up is enough. You get both excellent durability and simple maintenance.

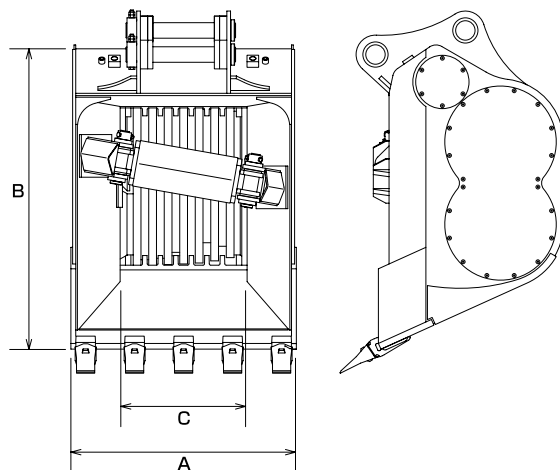

■ Specification table for Bucket Crusher

M o d e l	HR-200
Main body class reference ton	20~22
Maximum working pressure kgf/cm ²	280(relief valve setting value)
Bucket width A mm	1,163
Bucket length B mm	1,654
Crushing shaft width C mm	655
Capacity ton/h	20~60
Weight kg	2,500

※Hydraulic piping (not included) of the main body is required.※If the back pressure is more than 20kgf/cm², drain piping (not included) is required. ※It is not attachable to power shovels in different classes.

Concrete & asphalt cutting machine

Concrete Planer

TH-60
TH-120
TH-200

The dual drums powerfully process various cutting work at multi-purpose digging and cutting sites.

2-pump combination is also possible!!



You can cut asphalt, concrete, and hard soil quickly and powerfully!

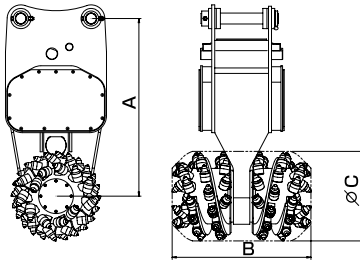

The compact and simple structure means easy handling and good visibility. It combines bit cutting with less noise and more excellent cost performance than other breakers. Use a single pump or a combination of 2 pumps.

■ Specification table for Concrete Planer

M o d e l	TH-60	TH-120	TH-200
Main body class reference ton	6~8	10~14	20~22
Maximum working pressure kgf/cm ²	280	320	350*
Main body length A mm	970	1,205	1,235
Drum width B mm	925	970	1,015
Drum outer diameter C mm	505	605	655
Number of Revolutions rpm	81 (120L/min)	110 (200L/min)	164 (400L/min)
Maximum output torque kgf-m	660	770	950
Cutting force kgf	2,600	2,600	2,900
W e i g h t kg	770	1,320	1,750
Adaptor type	○		

*A relief valve is mounted and the setting pressure is 280kgf/cm².

Asphalt cutting machine

Asphalt Planer

ES-30

This unit is good for asphalt chipping in road repair work. It is best as support for large cutting machines, small scale work on pavement and manhole areas.



Because of the individual movement of the arm attachment and cutting portion, it can make horizontal cutting without moving the main body.

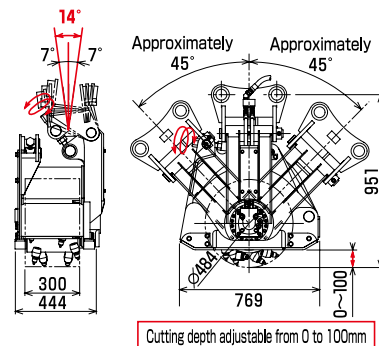

Cutting depth adjustable from 0 to 100mm

It tilts (patent) 7° to the right or left. It freely sets non-step cutting depth from 0 to 100mm. Because the cutting portion is covered by the main body, it ensures safe and comfortable work. It makes efficient cutting through the optimum layout for cutting and chipping. You can switch to concrete cutting by attaching the exclusive concrete cutting bit.

■ Specification table for Asphalt Planer

M o d e l	ES-30
Main body class reference ton	3~4
Number of Revolutions rpm	120 (50L/min)
Cutting width mm	300
Cutting depth mm	0~100
W e i g h t kg	380
Adaptor type	○

*Hydraulic piping of either breaker type or two-way type is necessary for Asphalt Planer.
*The concrete cutting bit is optional.

Asphalt & Concrete Planer

Bucket-type rotary sifter

DD-RIDDLE

DD-120
DD-200

DD-RIDDLE, handling like a bucket, realizes comfortable sifting work at recycling sites. It can be used for various types of industrial waste, garbage, burned ash, and gravel. A 2-pump combination is also possible!



The main body has a wide opening and an easy pull-out frame with an original honeycomb net. It rotates at a choice of speeds and makes separation work quickly. The curve structure means toughness in a light weight. It is a bucket-type sifter with little vibration and low noise, contributing to environment-friendly worksites.

The specifically-designed decelerator-attached motor has a longer life. The decelerator corresponds to high-load so that the bucket will not suffer wobble due to wear of the bushing. Screen change is easy.

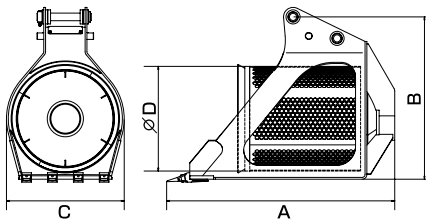

■ Specification table for DD-Riddle

Model	DD-120	DD-200
Main body class reference ton	10~14	20~22
Main body length A mm	2,080	2,400
Main body height B mm	1,440	1,710
Main body width C mm	1,070	1,240
Screen dimension D mm	930	1,100
Screen capacity m ³	0.65	1.0
Net size mm	HEX38	HEX38
Maximum number of revolutions rpm	45	45
Weight kg	1,140	1,660

※Hydraulic piping of either breaker type or two-way type is necessary for DD-Riddle.

Powerful coppice and grass cutter

Grass Cutter

KS-15
KS-30
KS-60
KS-120

Weeds, bamboo groves, and coppices can be cut quickly. Excellent cutting can be obtained even on slopes and ramps. The cutter is a tilt type with free-angle cutting.



The hammer knife means powerful crushing of weeds and coppice. Collection disposal is unnecessary because it mulches as it cuts.

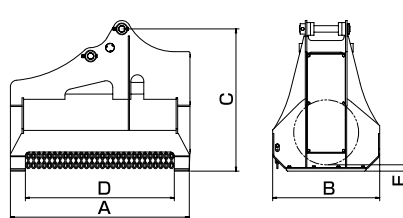

The hydraulic motor and belt drive mean low noise. The hydraulic valve mounted in the main body of Grass Cutter can supply optimum pressure flow.

■ Specification table for Grass Cutter

Model	KS-15	KS-30	KS-60	KS-120
Main body class reference ton	1.2~3	3~5	6~8	10~14
Maximum working pressure A mm	545	1,035	1,385	2,130
Total length B mm	480	660	830	1,025
Total height C mm	575	885	1,100	1,280
Cutting width D mm	445	850	1,150	1,840
Cutting height E mm	35	50		
Claw quantity (pcs)	12	18	24	42
Knife rim velocity m/sec	57	62	63	79
Weight kg	90	270	550	1,160

※Hydraulic piping of either breaker type or two-way type is necessary for Grass Cutter.

CB TYPE CLAM SHELL BUCKET

Free 360 swiveling and adaptation of the shell push clamshell method provide strong and speedy digging.

Standard type



This bucket strongly supports deep foundation digging of basement car parks, common duct earth removal work and steel tower foundations.

No more soil stuck in the bucket! An optional ejector forcibly discharges earth when the bucket is opened. It is especially best for argillaceous soil. A joint rod attachment exclusive for the clam shell bucket permits deeper digging exceeding levels you'd expect in this target class. A full lineup ranging from standard machines to mini-shovels are available.

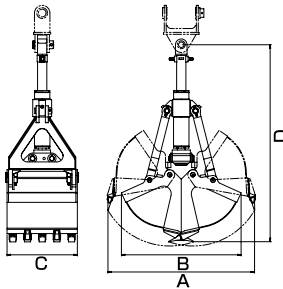

■ Specification table for standard Clam Shell Bucket CB Type

Model	CB-007	CB-010	CB-015	CB-020	CB-030	CB-040	CB-070	CB-080	CB-100
Main body class reference ton	3~4	4~5	6~8	10~14		20~22		30~35	
Maximum working pressure kgf/cm ²	250		280		350				
Bucket heap capacity m ³	0,07	0,10	0,15	0,20	0,30	0,40	0,70	0,80	1,00
Opening width A mm	955	1,050	1,255	1,405	1,560	1,785	1,900	2,020	2,195
Closing width B mm	725	810	905	1,035	1,190	1,340	1,550	1,660	1,635
Bucket width C mm	450		590		685		910		1,200
Main body length D mm	1,225	1,270	1,780	1,855	2,015	2,130	2,550	2,625	2,605
Weight kg	150	160	370	390	590	630	1,110	1,140	1,480

*The class of the main body is for reference. Ask your agent for more information.
*The ejector and joint rod are optional.

CKET

Round type



This bucket shows its power in deep foundation digging and pile construction. Digging with the round bucket reaches into the full corner of the side plane so that no workers are necessary inside the pile area. The work area stays safe and comfortable.

Deeper digging exceeds levels you'd expect in this target class. Attaching the joint rod exclusive for the clamshell bucket permits deeper digging. A full lineup ranging from standard machines to mini-shovels are available.

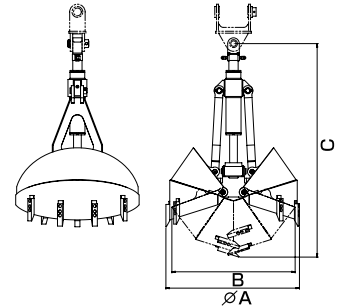

■ Specification table for round Clam Shell Bucket RC Type

Model	RC-060	RC-080	RC-095	RC-115	RC-145	RC-175	RC-195
Main body class reference ton	3~5	6~8	10~14		20~22		
Maximum working pressure kgf/cm ²	250	280	350				
Cutwater capacity m ³	0,02	0,04	0,08	0,14	0,31	0,56	0,79
(Heap capacity m ³)	(0,03)	(0,07)	(0,13)	(0,22)	(0,48)	(0,87)	(1,24)
Bucket opening diameter ∅ A mm	600	800	950	1,150	1,450	1,750	1,950
Bucket closing diameter ∅ B mm	515	695	845	1,010	1,310	1,600	1,800
Main body length C mm	1,210	1,645	1,725	1,950	2,110	2,765	2,860
Weight kg	120	280	330	580	720	1,330	1,490

*The main body class shows a reference value. Ask your agent for more information.
*The joint rod is optional.

KAI TYPE CLAM SHELL BUCKET

KAI 100
KAI 140
KAI 200

This is a clamshell bucket made exclusively for large power shovels. It is applicable for work under severe conditions. The enhanced and improved tough frame allows heavy digging using a large power shovel.

The KAI series is the best and most economical for piles with big bore diameter. It specializes in big bore diameter digging such as the caisson method. The total swivel shell push method ensures smooth impressing and efficient digging and loading.



**For large
power shovels!!**

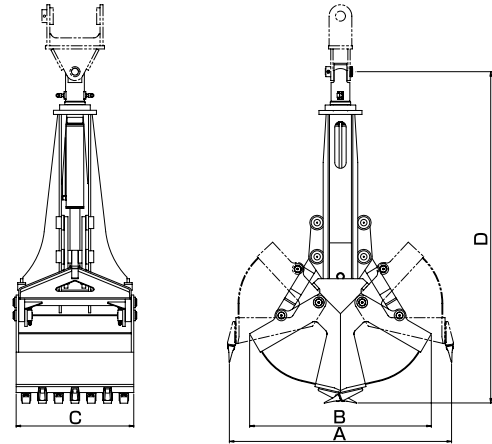

■ Specification table for big Clam Shell Bucket KAI Type

Model	KAI 100	KAI 140	KAI 200
Main body class reference ton	30~35	40~45	65
Maximum working pressure kgf/cm ²	350		
Bucket Heap Capacity m ³	1.13	1.40	2.00
Opening width A mm	2,200	2,500	2,660
Closing width B mm	1,840	2,100	2,300
Bucket width C mm	1,190	1,190	1,300
Main body length D mm	3,350	3,500	3,840
Weight kg	2,170	2,250	3,170

Drive Mixing

DM-120
DM-200

The hydraulic motor rotates the powerful rotor, concurrently powering the digging and mixing. Concurrent digging and mixing means uniform and high-speed mixing of various soil modifiers such as fixation agents.



Single-drive mixing is enough for foundation improvement work.

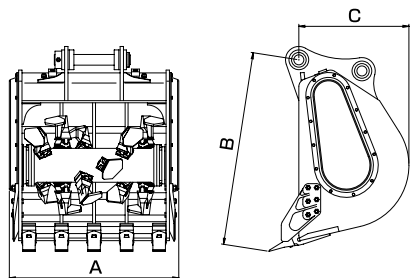

It is mounted with a flow control valve and gives stable performance with any shovel. It adapts to all kinds of models.

■ Specification table for Drive Mixing

Model	DM-120	DM-200
Main body class reference ton	10~14	20~22
Bucket width A mm	1,100	1,215
Bucket length B mm	1,230	1,450
Bucket depth C mm	725	825
Weight kg	820	1,290
Number of revolutions rpm	129	129
Maximum working pressure kgf/cm ²	350	

*Hydraulic piping (not included) of the main body is required. *If the back pressure is more than 20 kgf/cm², drain piping (not included) is required. *It is not attachable to power shovels in different classes.

Mixing Fork

MFK-30
MFK-40
MFK-60
MFK-120
MFK-200
MFK-300

The mixing fork securely performs stirring of soil improvement, cement, and other agents. Its shape is best for stirring, and it requires only regular bucket operation to stir steadily.



It comes in many varieties ranging from mini-class to standard machines. You can select the best for your application and work site.

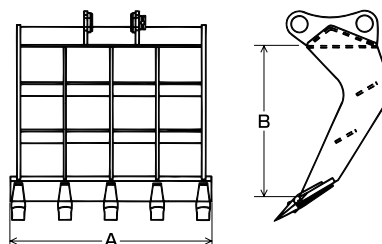

■ Specification table for Mixing Fork

Model	MFK-30	MFK-40	MFK-60	MFK-120	MFK-200	MFK-300
Main body class reference ton	3~4	4~5	6~8	10~14	20~22	30~35
Bucket width A mm	550	920	1,080	1,300	1,610	1,900
Bucket height B mm	425	640	770	970	1,160	1,440
Number of teeth	4	4	4	5	5	5

*The shape of the net differs according to the class.

Honeycomb Skeleton Bucket

HSK-60
HSK-120
HSK-200

The honeycomb skeleton bucket is an environment-friendly eco-specification skeleton bucket.



The honeycomb (hexagon)-shaped skeleton square means both light main body weight and low cost. The light weight improves mobility and efficiency. Fuel cost savings can reduce working costs, too.

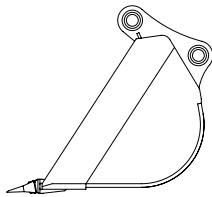
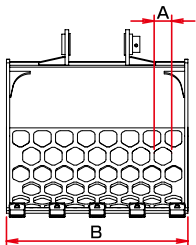

The honeycomb shape is adapted to the bucket skeleton. It can smooth ground in every orientation: front/back, right/left, and tilting just like you would using a standard bucket.

■ Specification table for Honeycomb Skeleton Bucket

Model	HSK-60	HSK-120	HSK-200
Main body class reference ton	6~8	10~14	20~22
Hexagon hole diameter A mm	80	120	120
Bucket width B mm	830	1,000	1,240
Weight kg	280	460	750

Skeleton Bucket

Standard type / Type E

Standard type
ST-15
ST-30
ST-40
ST-60
ST-120
ST-200
ST-300
ST-400
Type E
SE-60
SE-120
SE-200

This bucket is excellent for various sifter work, riverbed quarry work, and concrete stirring work.

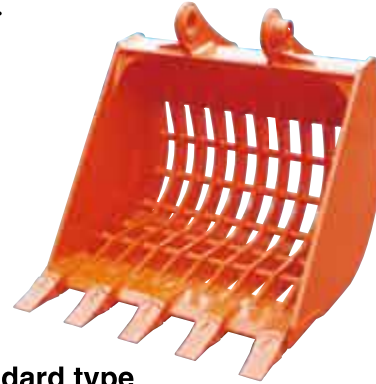

Standard type

Compared with regular buckets, it is applicable to tough work such as quarries thanks to enhancement of each operating part.

Type E

This is a "light" version of the standard type, not meant for large-scale work but an economical skeleton bucket with a light weight and a lower cost.

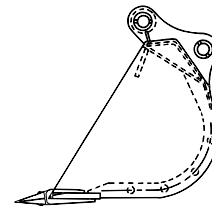
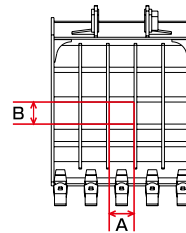

For square skeleton buckets, we can accommodate your custom application for an optimum size outside the standard specifications.

■ Specification table for Skeleton Bucket Standard type

Model	ST-15	ST-30	ST-40	ST-60	ST-120	ST-200	ST-300	ST-400
Main body class reference ton	1.2~3	3~4	4~5	6~8	10~14	20~22	30~35	40~45
Square (A×B) mm	50×50	80×90	80×100	150×150	150×160	100×150	150×200	100×150
Bucket width mm	540	660	670	846	1,033	1,248	1,431	1,572

*This specification is one example. It has a wide range of specifications in the square and bucket width. Ask your agent for more information.

■ Specification table for Skeleton Bucket type E

Model	SE-60	SE-120	SE-200
Main body class reference ton	6~8	10~14	20~22
Square (A×B) mm	100×150	100×165	150×200
Bucket width mm	828	971	1,226

*This specification is one example. It has a wide range of specifications in the square and bucket width. Ask your agent for more information.

Mini-Earth Augar

EA-30
EA-60

This is the best unit for preliminary digging of piling and building foundation work. The screws have a lineup diameter of 100 to 500mm and can be exchanged in accordance with your work. It is applicable to every work site.

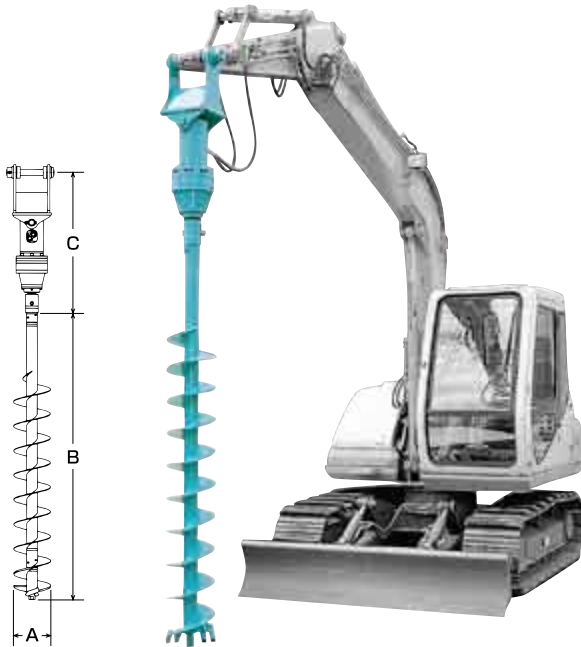

■ Specification table for Mini-Earth Augar

Model	EA-30		EA-60			
Main body class reference ton	3~5		6~8			
Screw diameter A mm	∅100	∅150	∅200	∅300	∅400	∅500
Screw length B mm	1,160		2,290		2,340	
Main body length C mm	1,110		1,220			
Maximum working pressure kgf/cm ²	250		280			
Maximum output torque kgf-m	225		680			
Rotation speed rpm	75 (40L/min)		46 (70L/min)			
Weight kg	140	150	250	270	330	390
Adaptor type	○					

The full-scale head & high torque mean constant, reliable digging.

The cross bits at the upper tip and cutting side bit are made of carbide tips so that they can securely dig any soil.

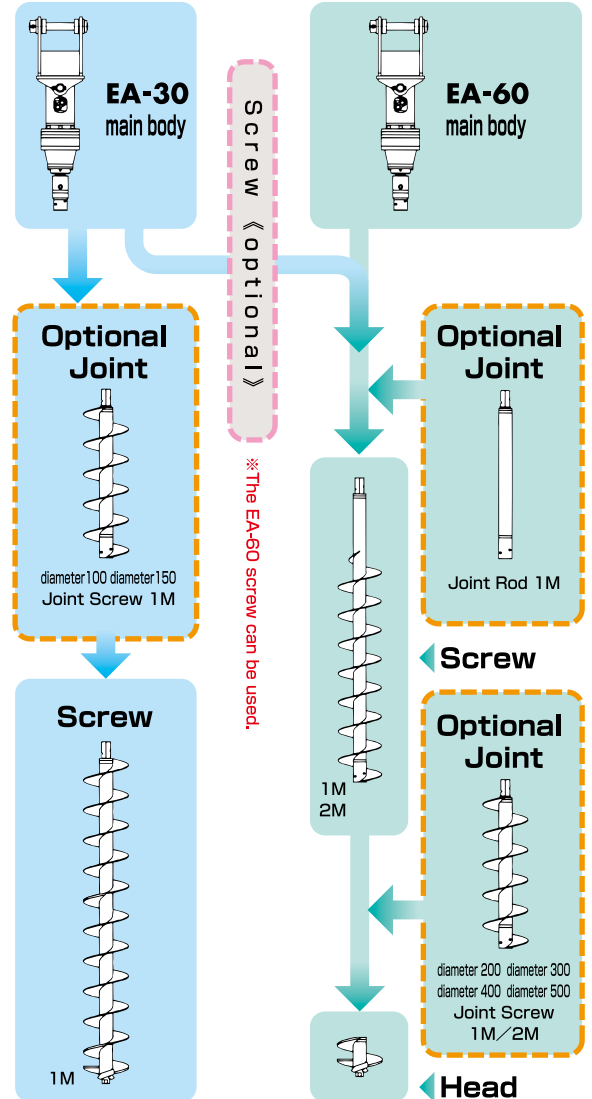

Tilt Slope Bucket

**TN-60
TN-120
TN-200**

Amazing tilt angle!! One side has a tilt angle of 45 degrees, which permits slope finish in bad footing sites and corner slopes where power shovels can't work. It is good for sites where regular slope buckets can't operate.



There is an adaptor type attachable to all models.

(The adaptor type is optional.)

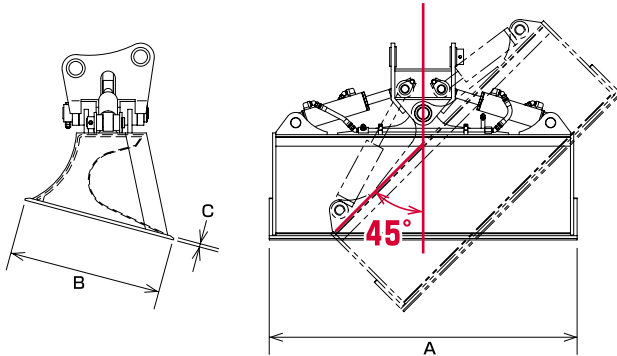

■ Specification table for Tilt Slope Bucket

Model	TN-60	TN-120	TN-200
Main body class reference ton	6~8	10~14	20~22
Maximum working pressure kgf/cm ²	280	350	
Bucket width A mm	1,400	1,800	2,000
Bucket depth B mm	750	900	1,000
Bucket basal plate thickness C mm	16	19	19

Slope Bucket Y-1

This is the best bucket for slope finishing. The reinforced arm mounting portion secures slope knocking work. Front loading work is no problem, either. The Y-1 model is good for ground-leveling and high accuracy slope work.

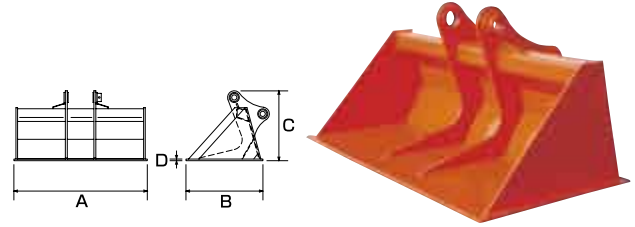

■ Specification table for Slope Bucket Y-1

Model	Y1-08	Y1-15	Y1-30	Y1-40	Y1-60	Y1-120	Y1-200	Y1-220	Y1-300
Main body class reference ton	0.7~1.5	1.2~3	3~4	4~5	6~8	10~14	20~22	22~24	30~35
Bucket width A mm	500	800	1,000	1,200	1,300	1,600	2,000	2,200	2,400
Bucket depth B mm	300	400	500	600	750	900	1,000	1,100	1,200
Bucket height C mm	225	304	380	450	500	590	660	710	792
Bucket basal plate thickness D mm	9	12	12	12	16	19	19	19	25

Slope Bucket Y-2

Even better for loading work than the Y-1! Regular slope work is easy, too. It's the ultimate bucket for slope finish and loading work.

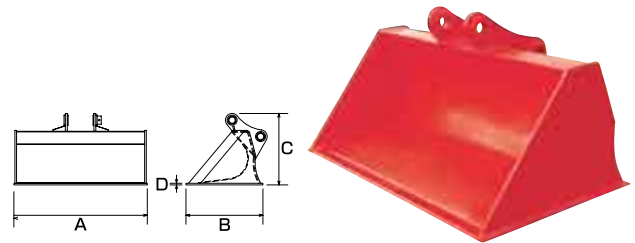

■ Specification table for Slope Bucket Y-2

Model	Y2-08	Y2-15	Y2-30	Y2-40	Y2-60	Y2-120	Y2-200	Y2-300
Main body class reference ton	0.7~1.5	1.2~3	3~4	4~5	6~8	10~14	20~22	30~35
Bucket width A mm	500	800	1,000	1,200	1,300	1,600	2,000	2,400
Bucket depth B mm	300	400	500	600	750	900	1,000	1,200
Bucket height C mm	205	275	340	410	515	610	680	805
Bucket basal plate thickness D mm	9	12	12	12	16	19	19	25

Slope Bucket N-1

N1-08
N1-15
N1-30
N1-40
N1-60
N1-120
N1-200
N1-300

The N-1 model is good for paddy improvement. This bucket, also called a 'flat bucket,' is good for paddies and slopes. It is best for residential development, farm land consolidation, and road slope finish work.

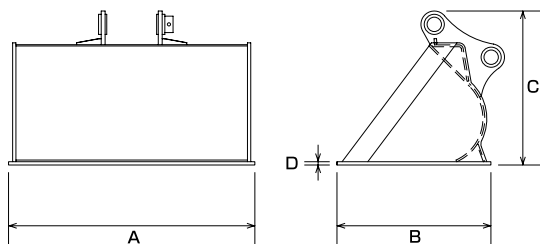

■ Specification table for Slope Bucket N-1

Model	N1-08	N1-15	N1-30	N1-40	N1-60	N1-120	N1-200	N1-300
Main body class reference ton	0.7~1.5	1.2~3	3~4	4~5	6~8	10~14	20~22	30~35
Bucket width A mm	500	800	1,000	1,100	1,200	1,300	1,500	1,700
Bucket depth B mm	300	400	500	600	750	900	1,000	1,200
Bucket height C mm	259	372	445	512	595	710	815	960
Bucket teeth thickness D mm	9	12	12	12	16	19	19	25

*Other buckets including a slope bucket specifications are available. Ask your agent for more information.

G Bucket

This is an original bucket shape of Toku Pneumatic. We offer you various sizes to meet your various needs, including reinforced models according to work sites by manufacturer and class.

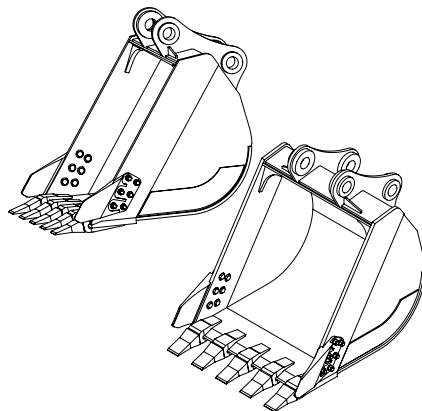

Triangle Bucket

This is also called a 'culvert bucket,' good for digging of drainage and irrigation canals.

TB3-30
TB3-40
TB3-60
TB3-120
TB3-200
TB1-30
TB1-40
TB1-60
TB1-120
TB1-200
TBC-120



■ Specification table for Triangle Bucket TB3

Model	TB3-30	TB3-40	TB3-60	TB3-120	TB3-200
Main body class reference ton	3~4	4~5	6~8	10~14	20~22
Tilt angle A °	73.3°(3min)	73.3°(3min)	73.3°(3min)	73.3°(3min)	73.3°(3min)
Bucket top width B mm	300	300	300	300	300

■ Specification table for Triangle Bucket TB1

Model	TB1-30	TB1-40	TB1-60	TB1-120	TB1-200
Main body class reference ton	3~4	4~5	6~8	10~14	20~22
Tilt angle A °	45°(10%)	45°(10%)	45°(10%)	45°(10%)	45°(10%)
Bucket top width B mm	180	180	200	300	400

■ Specification table for Triangle Bucket TBC

Model	TBC-120
Main body class reference ton	10~14
Tilt angle A °	82.3°
Bucket top width B mm	250

Ripper Bucket

The ripper bucket enables digging work in rock beds and hard soil where standard buckets are inoperable. The ripper point mounted in the bucket center and the specially reinforced bucket can dig any soil.

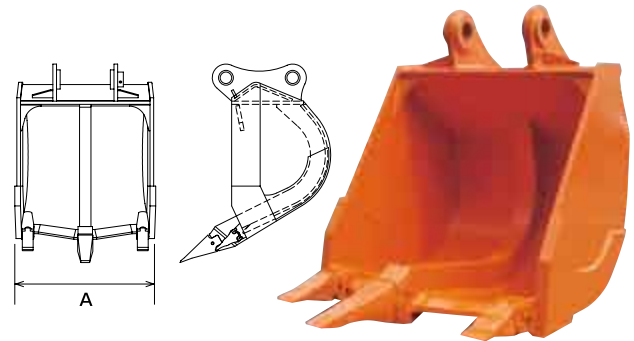

■ Specification table for Ripper Bucket

Model	RB-40	RB-60	RB-120	RB-200	RB-220	RB-300	RB-400
Main body class reference ton	4~5	6~8	10~14	20~22	22~24	30~35	40~45
Main body length A mm	619	726	932	1,050	1,050	1,236	1,344

Single Ripper

This is a model specific to dig out underground rocks and concrete lumps. Excavated rocks can be loaded by the rock grasper. Get the ripper with a rock grasper as a set.

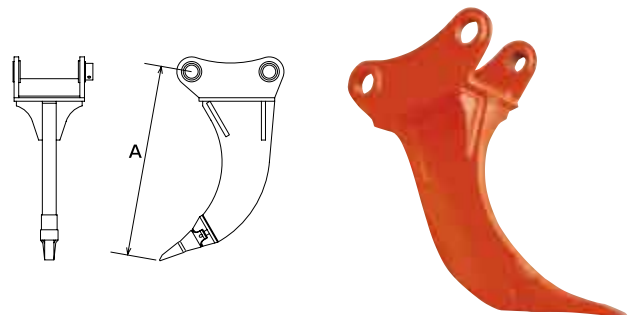

■ Specification table for Single Ripper

Model	RI-40	RI-60	RI-120	RI-200	RI-300	RI-400
Main body class reference ton	4~5	6~8	10~14	20~22	30~35	40~45
Main body length A mm	830	985	1,033	1,214	1,550	1,638

※The length of the main body is the length from the arm top mounting boss to the point end.

Extension Arm

This arm enables work in high/low spots where standard arms can't reach. The work range is much wider, reducing construction schedule needs. Each model and class has a variety of lengths so that you can select based on the needs of your work sites.

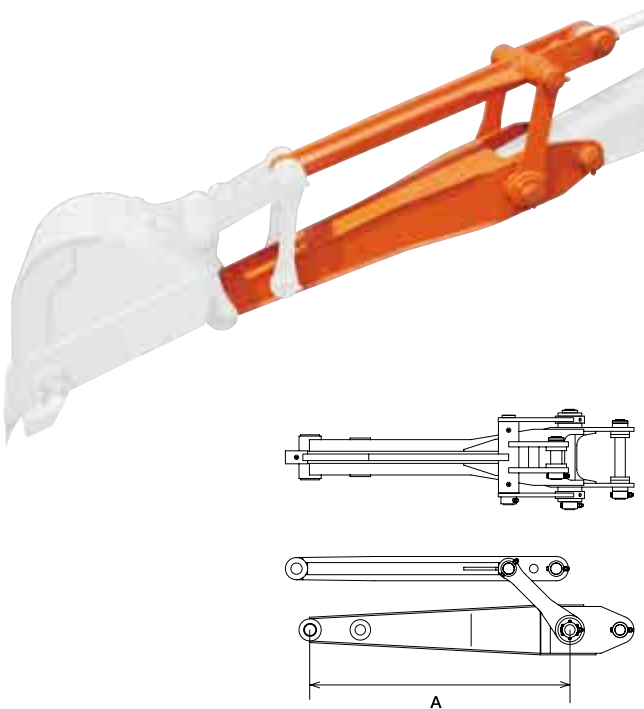

■ Specification table of Extension Arm

Model	XA-08	XA-15	XA-30	XA-40	XA-60
Main body class reference ton	0.7~1.5	1.2~3	3~4	4~5	6~8
Extension length A mm	400 600	600 700	600 800	600 800	800 1,000

Model	XA-120	XA-200	XA-220	XA-300
Main body class reference ton	10~14	20~22	22~24	30~35
Extension length A mm	1,200 1,500	1,500 2,000	2,000 2,500	2,000 2,500

*The extension length is one example. Each class has a wide variety of sizes.

Original special models



List of corresponding hydraulic shovels by model

*1 Except for 1 orange bucket, and clam shell bucket. Ask our agent for models other than those in the following list.

Model*1	-08	-15	-30	-40	-60	-120	-200	-300	-400	
Main body class reference: ton	0.7~1.5	1.2~3	3~4	4~5	6~8	10~14	20~22	30~35	40~45	
Manufacturers	Komatsu Ltd.	PC10MR-2	PC18MR-3	PC27MR-3	PC40MR-3	PC78US-8	PC120-8	PC200-8	PC300-8	PC400-8
		PC10UU-5	PC20MR-3	PC30MR-3	PC55MR-3	PC78UU-6	PC128US-8	PC210-8	PC350-8	PC450-8
			PC20UU-3	PC30UU-5	PC58UU-5		PC128UU-8	PC220-8		
				PC35MR-3			PC138US-8	PC228US-3		
				PC38UU-5				PC230-8		
	Hitachi Construction Machinery Co., Ltd.	ZX8U-2	ZX17U-2	ZX30U-3	ZX40U-3	ZX70-3	ZX110-3	ZX200-3	ZX330-3	ZX400R-3
		ZX10U-2	ZX20U	ZX30UR-2	ZX50U-3	ZX75UR-3	ZX120-3	ZX225US-3		
		ZX15UR	ZX20UR	ZX35U-3	ZX55UR-2	ZX75US-3	ZX135US-3	ZX225USR-3		
			ZX22U-2	ZX40UR-2						
			ZX27U-3							
	Shin Caterpillar Mitsubishi Ltd.	008CR	302CSR	303CSR	305CSR	307D	311DRR	320D	336D	345D
		010CR	301.5CR	303CCR	305CCR	308DCR	313DCR	320DRR		
			302CCR	303.5CCR	304CCR	308DSR	313DSR	320DLN		
				304CSR			314DCR	321DCR		
							312D			
	Kobelco Construction Machinery Co., Ltd.	SK005-3	SK15SR-3	SK30SR-5	SK40SR-5	SK75UR-5	SK125SR	SK200-8	SK330-8	SK460-8
		SK007-6	SK20SR-5	SK30UR-5	SK50UR-5	SK70SR-2	SK130UR-1ES	SK225SR	SK350LC-8	SK480LC-8
		SK09SR	SK20UR-2	SK27SR-5	SK50SR-5		SK125W-3	SK235SR-2		
				SK35SR-5			SK135SR-2	SK210LC-8		
	Sumitomo Construction Machinery Co., Ltd.					SH75X-3B	SH120-5	SH200-5	SH330-5	SH460HD-5
						SH75XU-3B	SH125X-3B	SH225X-3B	SH350HD-5	
						SH125XU-3B				
						SH135X-3B				
Kato Works Co., Ltd.					HD308US	HD512Ⅲ	HD820V	HD1430V	HD2045Ⅲ	
						HD513MRⅢ	HD823MRⅢ			
IHI Construction Machinery Ltd.	10VZ	15VX	35VX	40VXL	80VX					
	8VX	20VX	40Z	40VX						
		25VX	30VX	45VX						
		20VZ	30VZ	55VX						
				50VZ						
YANMAR Co., Ltd.	ViO10-2A	ViO17	ViO27-5	ViO40-5	B7Σ(B7-5A)					
		B2Σ(B2-5)	B3Σ(B3-6)	ViO50-5	ViO70-3					
		ViO20-3	ViO30-5	B6Σ(B6-6)						
			ViO35-5							
Kubota Corporation	U-10-3	U-17	RX305	U-40-5	K-75US	K-125US	K-200-3			
	U-008	U-20-3S	U-30-5	RX505	K-70	K-110	K-225US-3			
		U-25-3S	U-35-5	U-50-5	K-75UR	K-120	K-225USR-3			
		RX153S	RX405			K-135US				
		RX203S	K-035-5			K-135UR				



TOKU PNEUMATIC CO.,LTD.

3-4, 4-Chome Katakasu, Hakata-ku, Fukuoka 812-0043 Japan
Phone: +81-92-431-0401 Fax: +81-92-431-1014

<http://www.toku-net.co.jp/en>